

PeakTech®

Unser Wert ist messbar...

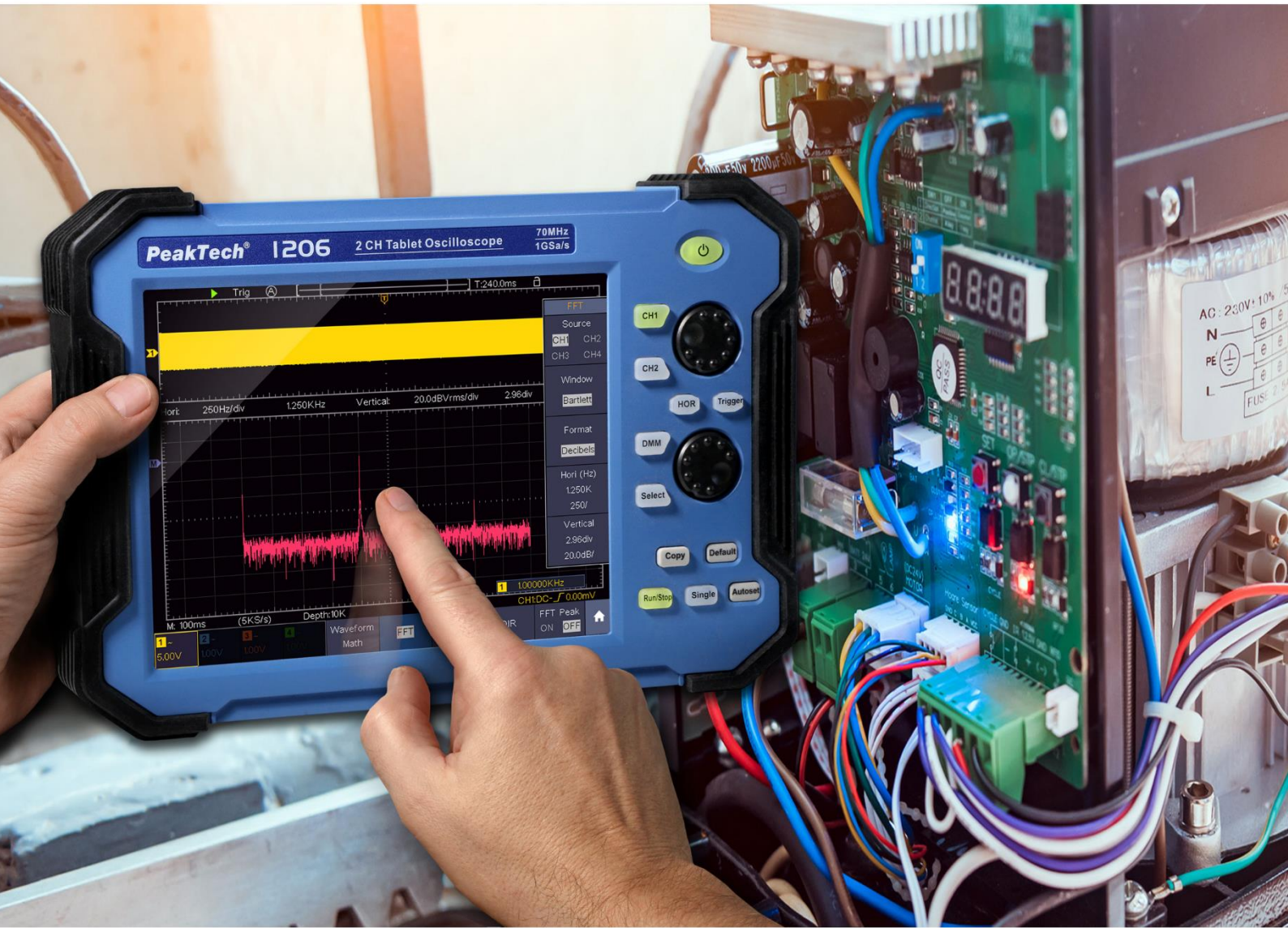

PeakTech® 1206 - 1212

User Manual

2 CH & 4 CH

Tablet Oscilloscopes

Table of content

1. Safety precautions	3
2. Safety symbols and terms	5
3. Quick start guide	7
3.1 Front	8
3.2 Side view	10
3.3 Upper side	11
4. Introduction to the user interface	12
5. Check before commissioning	13
5.1 Functional test	14
5.2 Probe compensation	15
5.3 Setting the probe attenuation factor	15
5.4 Self - calibration	17
5.5 Introduction to the vertical system	17
5.6 Introduction to the horizontal system	18
5.7 Introduction to the trigger system	19
5.8 Introduction to the touchscreen operation	20
5.8.1 Change menu.....	20
5.8.2 Value setting in the menu.....	20
5.8.3 Calling up the main menu.....	21
5.8.4 Selection of the active channel.....	21
5.8.5 Adjustment of the horizontal and vertical.....	22
5.8.6 Setting the trigger level.....	22
5.8.7 Setting the time base and voltage division.....	23
5.8.8 Measurements using the Cursor.....	23
6. User instructions (for advanced users)	24
6.1 Set the vertical system	25
6.1.1 Setting the channel coupling.....	26
6.1.2 Setting the probe attenuation.....	26
6.1.3 Current measurement.....	26
6.1.4 Invert a waveform.....	26
6.1.5 Setting the bandwidth limit.....	27
6.2 Set the horizontal system	27
6.3 Waveform zoom function	27
6.4 Operation of the function menu	28
6.5 Set the trigger system	28
6.5.1 Single Trigger.....	28
6.5.2 Edge Trigger.....	29
6.5.3 Video Trigger.....	30
6.5.4 Pulse Width Trigger.....	31
6.5.5 Slope Trigger.....	31
6.5.6 Runt Trigger.....	33
6.5.7 Window Trigger.....	34
6.5.8 Timeout Trigger.....	35
6.5.9 Nth Edge Trigger.....	36
6.5.10 Logic Trigger.....	37
6.5.11 Bus Trigger.....	38
7. Sampling setup	41
8. Implementation of the function setting for the auxiliary system	43
8.1 Set the display system	45
8.1.1 Persist.....	45
8.1.2 Color.....	46
8.1.3 Counter.....	46

8.2 Save and recall a waveform	47
8.2.1 Save and recall the waveform.....	48
8.2.2 Save the current screen image.....	49
8.2.3 Requirements of the USB storage device.....	49
8.2.4 Use system provided function to format the USB device.....	49
8.2.5 Record and playback waveforms.....	51
8.2.6 Clone and recall a waveform.....	54
8.2.7 Data format description of OTA waveform file.....	56
9. Measurement functions	57
9.1 Measure automatically	57
9.1.1 Measure.....	58
9.1.2 Automatic measurement of the voltage parameters.....	59
9.1.3 Automatic measurement of the time parameters.....	60
9.1.4 Other measurement functions.....	61
9.1.5 Adjustment of the automatic measurement.....	61
9.2 Measure with the cursor	62
9.2.1 Cursor measurements in FFT mode.....	64
9.3 Mathematical manipulation function	64
9.4 User defined function	66
9.5 Digital filter	67
9.6 Autoscale function	67
9.7 FFT function	69
9.7.1 Select the FFT window.....	70
9.8 XY mode	71
9.9 Pass/Fail	71
10. Executive buttons	73
10.1 Print the screen image	74
11. Using the multimeter	75
11.1 Connections of the multimeter	75
11.2 Menu of the multimeter	75
11.3 DMM information window	77
11.4 Measurements with the multimeter	78
11.4.1 AC/DC voltage measurement.....	78
11.4.2 AC/DC current measurement.....	78
11.4.3 Resistance measurement.....	78
11.4.4 Testing diodes.....	79
11.4.5 Capacitance measurement.....	79
11.4.6 Continuity test.....	79
11.5 Multimeter features	80
11.5.1 Data – Hold Mode.....	80
11.5.2 Information display.....	80
11.5.3 Auto or manual range.....	80
11.5.4 Relative measurements.....	80
11.6 Multimeter recorder	81
12. Communication with PC	83
12.1 USB port	83
12.2 LAN port	84
13. Specification	87
13.1 Trigger	90
13.2 Multimeter	92
14. General specifications	93

1. Safety precautions

This product complies with the requirements of the following directives of the European Union for CE conformity: 2014/30/EU (electromagnetic compatibility), 2014/35/EU (low voltage), 2011/65/EU (RoHS).

Overvoltage category II; Pollution degree 2.

To ensure the operational safety of the device and to avoid serious injuries from current or voltage flashovers or short circuits, the following safety instructions for operating the device must be observed.

Only connect the device to sockets with a grounded protective conductor

Damages caused by non-observance of these instructions are excluded from claims of any kind.

- * This device must not be used in high-energy circuits.
- * Before connecting the device to a socket, check that the voltage setting on the device corresponds to the existing mains voltage
- * Only connect the device to sockets with a grounded protective conductor
- * Do not place the device on a damp or wet surface.
- * Do not operate the device in the vicinity of strong magnetic fields (motors, transformers, etc.)
- * Do not exceed the maximum permissible input values under any circumstances (risk of serious injury and / or destruction of the device)
- * The specified maximum input voltages must not be exceeded. If it cannot be ruled out unequivocally that these voltage peaks are exceeded due to the influence of transient interference or for other reasons, the measurement voltage must be pre-damped accordingly (10: 1).
- * Before switching to another measuring function, disconnect test leads or probe from the measuring circuit.
- * Check the device, test leads and other accessories for possible damage or bare or kinked cables and wires before commissioning. If in doubt, do not take any measurements.
- * Only carry out measurements in dry clothing and preferably in rubber shoes or on an insulating mat.
- * Do not touch the measuring tips of the test leads.
- * Strictly observe the warning notices on the device.
- * The device should not be operated unsupervised
- * Do not expose the device to extreme temperatures, direct sunlight, extreme humidity or moisture.
- * Avoid strong vibration.
- * Keep hot soldering guns away from the immediate vicinity of the device.
- * Before starting the measuring operation, the device should be stabilized to the ambient temperature (important when transporting from cold to warm rooms and vice versa)
- * Do not exceed the set measuring range with any measurement. This will prevent damage to the device.
- * Clean the housing regularly with a damp cloth and a mild detergent. Do not use any caustic abrasives.
- * Avoid any proximity to explosive and flammable materials.
- * Opening the device and maintenance and repair work may only be carried out by qualified service technicians.
- * Do not place the device face down on the workbench or work surface to avoid damaging the controls.
- * Do not make any technical changes to the device.
- * **-Measuring devices do not belong in the hands of children-**

Warning!

If the oscilloscope is connected to an input signal of more than 42V peak (30V_{eff}) or to circuits with more than 4800VA, please observe the instructions below to avoid fire or electric shock:

- Use only insulated probes and test leads.
- Check all accessories before use and replace them if damaged. If in doubt, do not take any measurements.
- Remove the USB cable that connects the oscilloscope to the computer.
- Never exceed the maximum specified input voltages. Since the voltage is transmitted directly to the oscilloscope with the aid of the probe, the device can be damaged or there is a risk of injury from electric shocks.
- Do not use exposed BNC or banana plugs.
- Do not insert any metal objects into the connections.

Cleaning the device:

Before cleaning the device, pull the plug out of the socket. Only clean the device with a damp, lint-free cloth. Use only commercially available detergents.

When cleaning, make sure that no liquid gets inside the device. This could lead to a short circuit and the destruction of the device.

2. Safety symbols and terms



You can find the following symbols in these operating instructions or on the measuring device.

Warning!

„Warning” indicates conditions and operating steps that pose a risk to the operator.



Attention!

„Attention” indicates conditions and operating steps that can cause damage to the product or other objects.

Danger: High voltage

See user manual

Protective conductor terminal

Device grounding

Earth clamp (Ground)



In order to avoid physical damage and damage to the measuring device and the measuring objects, you should read the following paragraph carefully and always pay attention to it during future use. This device may only be used for the intended areas of application.



Warning:

The channels of the oscilloscope are not electrically isolated from one another. Therefore, the measuring channels should be on a common ground during a measurement. To avoid short circuits, the earth terminals must not be connected to different, non-isolated DC levels.

Internal Ground (GND) Wiring Diagram:

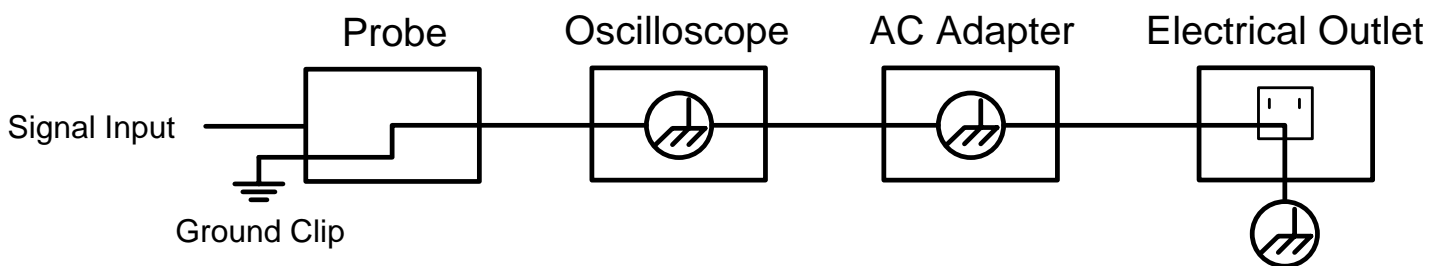

Due to the internally connected earth terminals between the BNC socket, USB port and IEC connector, the mains voltage should not be measured when the oscilloscope is operated with mains voltage in conjunction with a PC operated with mains voltage. In the event of a fault, a voltage flashover could occur across the GND of the PC.

Internal ground (GND) wiring diagram when the oscilloscope is connected to a PC:

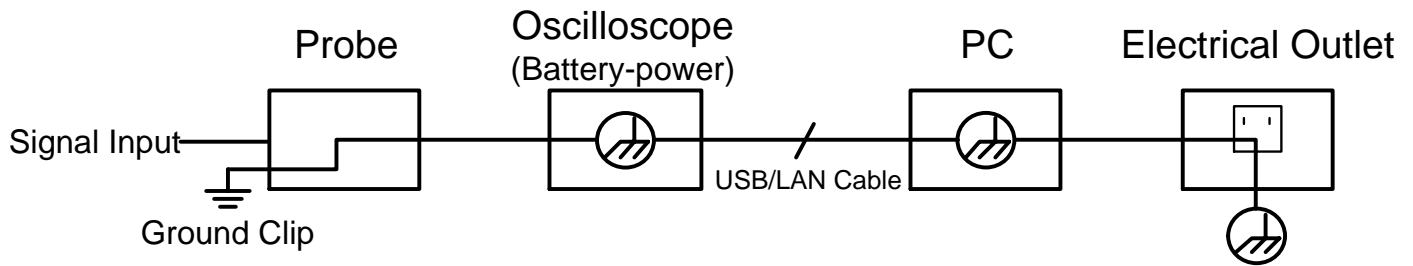

Warning:

To avoid fire or electric shock, please observe the following points when the connected oscilloscope input signal is greater than 42 Vpp (30 Vrms) or circuits greater than 4800 VA:

1. Use only insulated measuring probes and measuring lines
2. Check the accessories for damage and functionality before use
3. Remove the test leads and any accessories after measurement / use
4. Remove the USB cable from the oscilloscope before each measurement
5. Make sure that the voltage to be measured does not exceed the maximum input voltage of the device, as the measuring voltage is transmitted directly from the measuring probe to the oscilloscope
6. Do not use damaged connection cables, e.g. damaged BNC plugs
7. Do not insert any bare metal objects into the connections of the device

3. Quick start guide

This chapter covers the following topics:

- Structure of the oscilloscope
- Introduction to the user interface
- Check before commissioning
- Functional test
- Probe compensation
- Probe attenuation
- Safety by using the probe
- Performing the self calibration
- Introduction to the vertical system
- Introduction to the horizontal system
- Introduction to the trigger system
- Introduction to touchscreen operation

Structure of the oscilloscope

When you get a new oscilloscope, the first thing to do is familiarize yourself with its control panel. This chapter provides a simple description of the operation and functionality of the oscilloscope control panel so that you can quickly become familiar with its use.

3.1 Front

Function keys and rotary switches are built into the front of the oscilloscope, which can be used to navigate through the menu or to select function applications. Furthermore, the tablet oscilloscope has a touchscreen, which means that the respective functions can also be selected.

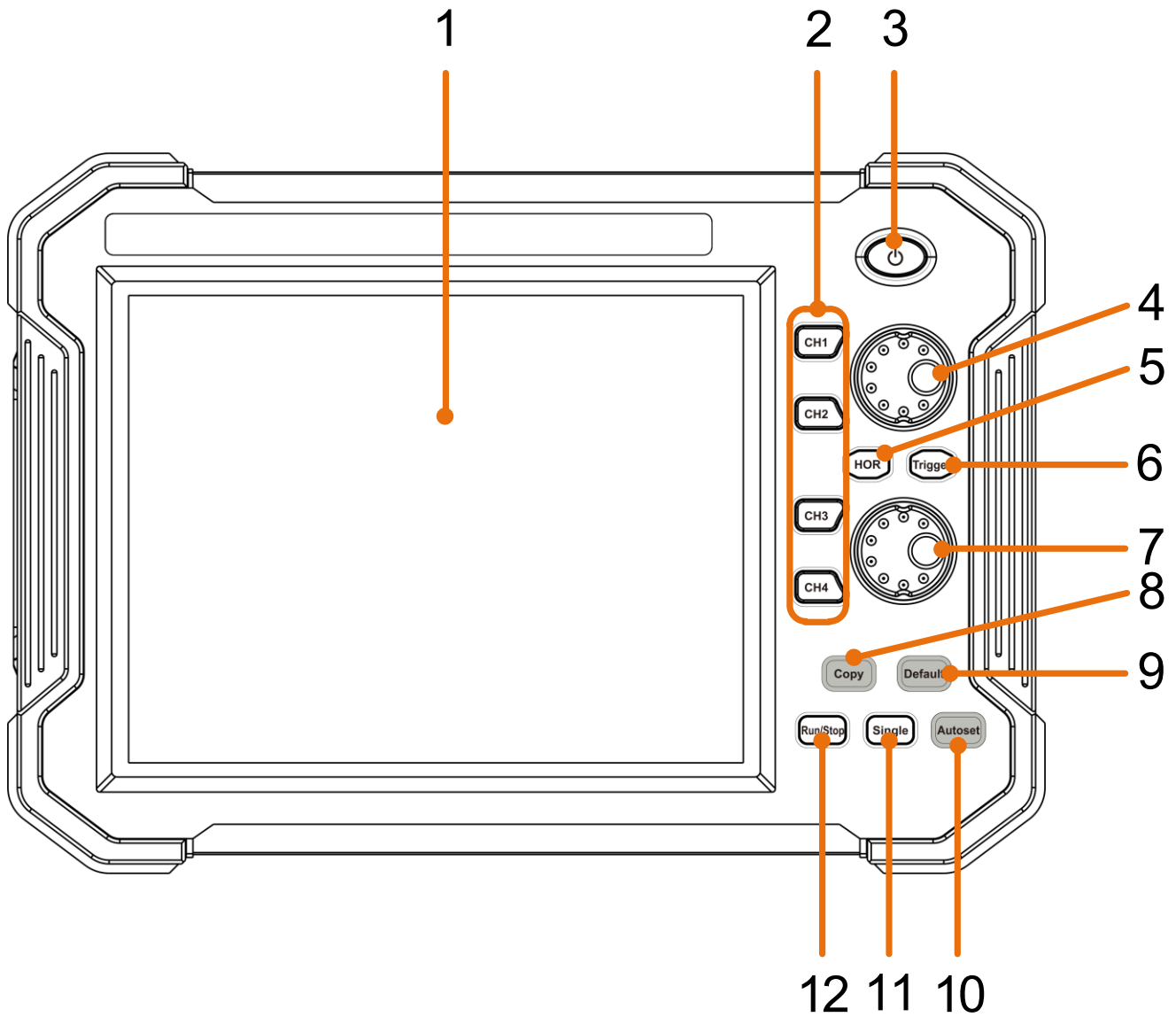

Figure 1.0 Front view (4 channel oscilloscope)

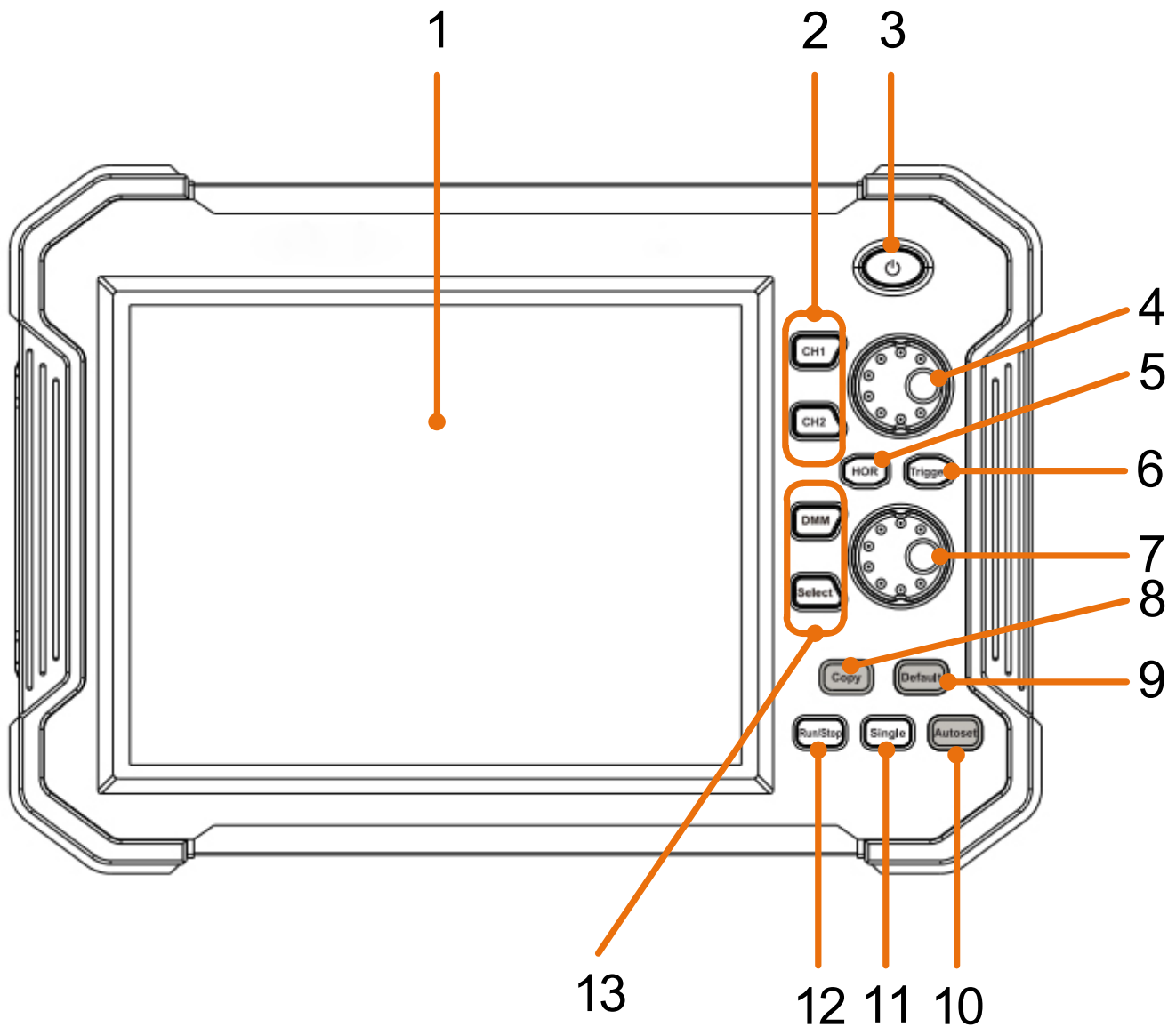

Figure 1.1 Front view (2 channel oscilloscope)

1. LCD Touchscreen
2. 4CH Oscilloscope: CH buttons CH 1 – CH 4 /
2CH Oscilloscope: buttons CH 1 + CH 2
3. Main switch for switching the device on and off
4. When a channel button lights up, the vertical position of the channel is set with the rotary button. When the HOR button is lit, the horizontal position of the channels is set (including math operations)
5. The HOR key is used to adjust the horizontal position of the various channels using the rotary knobs.
6. The trigger button is used to set the respective trigger level for the various channels. To do this, the lower rotary knob is used after activating the trigger button.
7. Rotary knob for setting the trigger level and the horizontal position of the measurement voltage
8. Using the Copy button, it is possible to save the current measurement
9. Button for restoring the factory settings. When pressed, you will be asked to press the button again to restore the factory settings
10. Autoset button for quick configuration of the oscilloscope to the current measurement signal
11. With the single button you are able to apply the trigger individually to a channel
12. Activates or deactivate the sampling of the input signal
13. Activates and deactivate the multimeter function

3.2 Side view

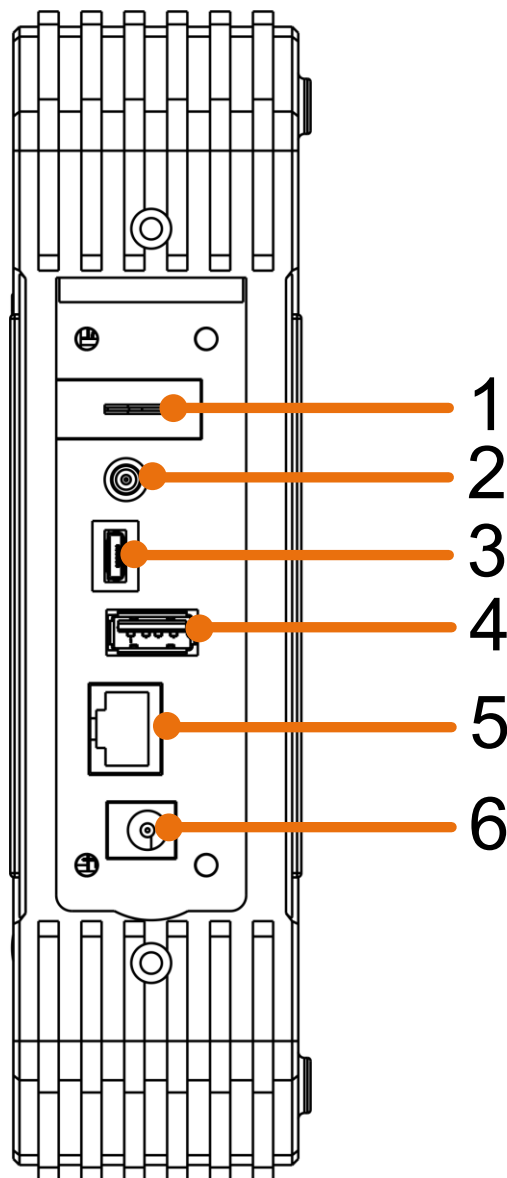

Figure 1.2 Side view

1. Probe compensation: output of the 5V / 1kHz measuring signal
2. Output connection for the trigger and the pass / fail function (output type can be changed in the menu Tool → Function → output → output)
3. USB device connection for transferring saved data e.g. to a PC
4. USB port for direct storage of data, e.g. on a USB stick
5. LAN port for connection to a PC
6. Charging connection socket for the enclosed charging adapter

3.3 Upper side

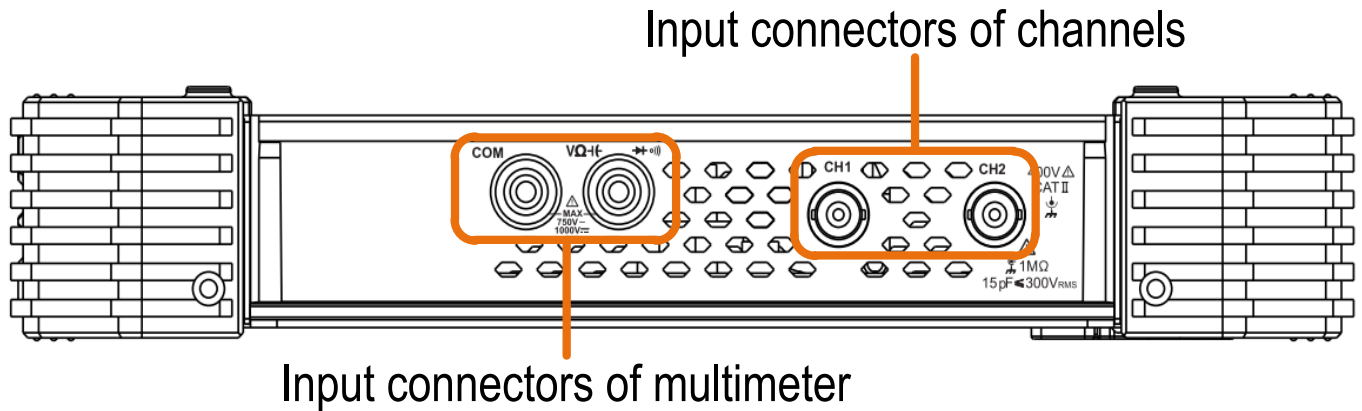

Figure 1.3 Upper side of the 2 channel oscilloscope (PeakTech 1206, 1207)

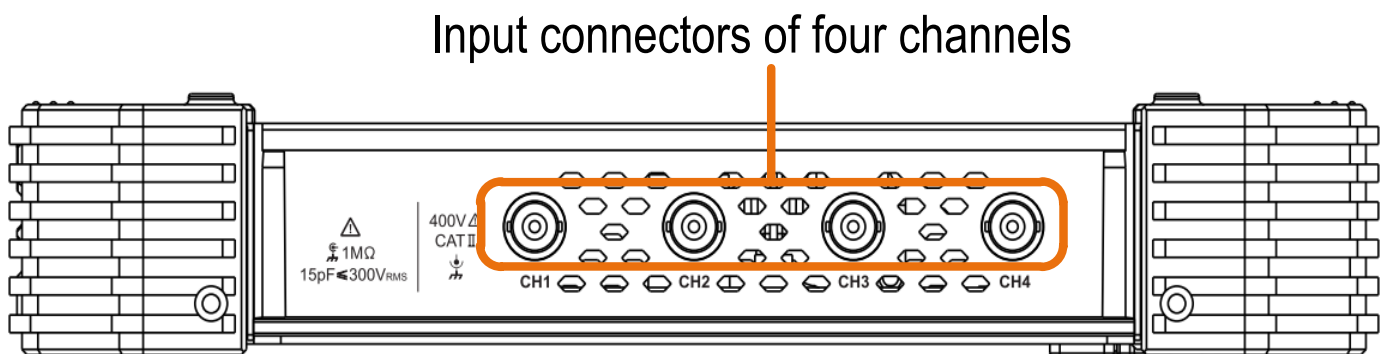

Figure 1.4 Upper side of the 4 channel oscilloscope (PeakTech 1211, 1212)

4. Introduction to the user interface

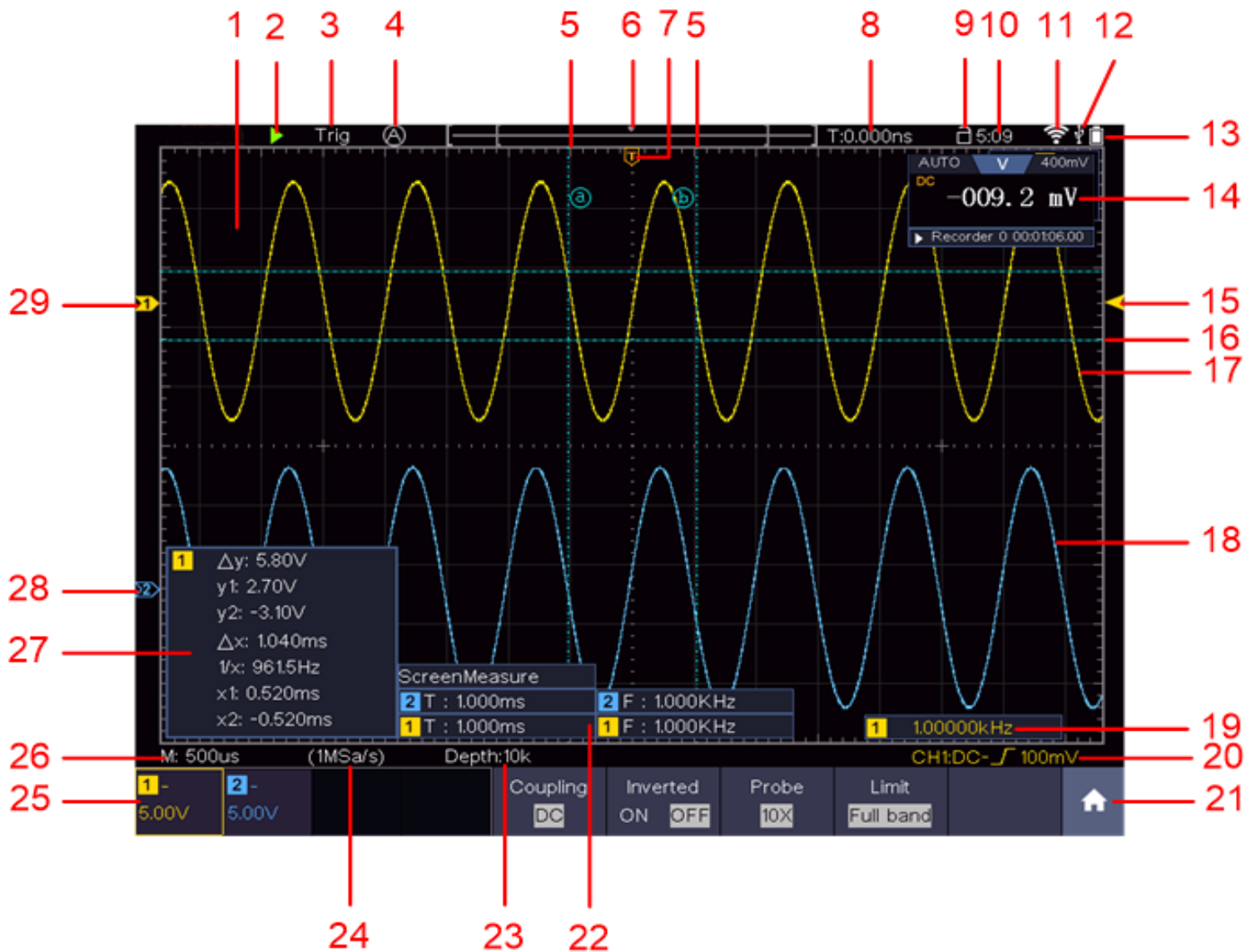

Figure 2.0 User interface

1. Display range of the measured values
2. Start / stop the measurement (measurement activated / deactivated)
3. Display of the selected mode
4. Automatic setting for displaying the measured value
5. Representation of the vertical position of the cursor measurement
6. Display of the current trigger position of the bandwidth
7. Display of the horizontal trigger position
8. Display of the current trigger value and the location of the internal memory
9. Option to lock the touchscreen operation
10. Time display
11. Wifi display
12. Display when an external USB device is connected
13. Battery level indicator
14. Display of the multimeter function
15. Channel 1 waveform
16. Display of the trigger position of the channel
17. Display of the horizontal position of the measuring cursor
18. Channel 2 waveform

19. Display of the frequency of the triggered signal
20. Display of the current trigger type
21. Selection to display the submenu items
22. Display of the measured type of the corresponding channel
23. Display of the recording length of the measured values
24. Display of the current sampling rate
25. Display of voltage division, zero point position and bandwidth limit, as well as symbol for coupling type
26. Display of the set main time base
27. Window to show the absolute measured values of the respective channel
28. Position of the zero point position of the channel 2 waveform
29. Position of the zero point position of the channel 1 waveform

5. Check before commissioning

After receiving a new oscilloscope, it is recommended that you test the device as follows:

1. Check whether the device has been damaged in transit.

If you note that the cardboard packaging or the protective foam padding are badly damaged, keep them until the entire device and its accessories have passed the electrical and mechanical test.

2. Check the accessories

Check that the accessories are complete. If any accessories are missing or damaged, please contact your dealer.

3. Check the device

If you note any damage to the exterior of the device, or if the device is not working properly or if the performance test does not pass, please contact your dealer. If the device has been damaged during transport, please keep the outer packaging and also inform your dealer about the damage.

5.1 Functional test

Check the meter is working properly as follows

1. **Switch on the device with the main switch " ⏻ " by pressing and holding the button.**

The device performs a self-test and displays the PeakTech logo. If desired, press the "Default" button to reset the oscilloscope to the factory settings. The default value for the probe attenuation in the menu is 10X.

2. **Set an attenuation of 10x on the probe and connect the probe to the CH1**

Align the slot on the probe with the channel 1 BNC connector and rotate the probe clockwise to secure it in place.

Connect the tip of the probe and the earth terminal to the plug of the task head compensator.

3. **Press the "Autoset" button**

The square wave signal with a frequency of 1 KHZ and a 5V SS value is displayed after a few seconds

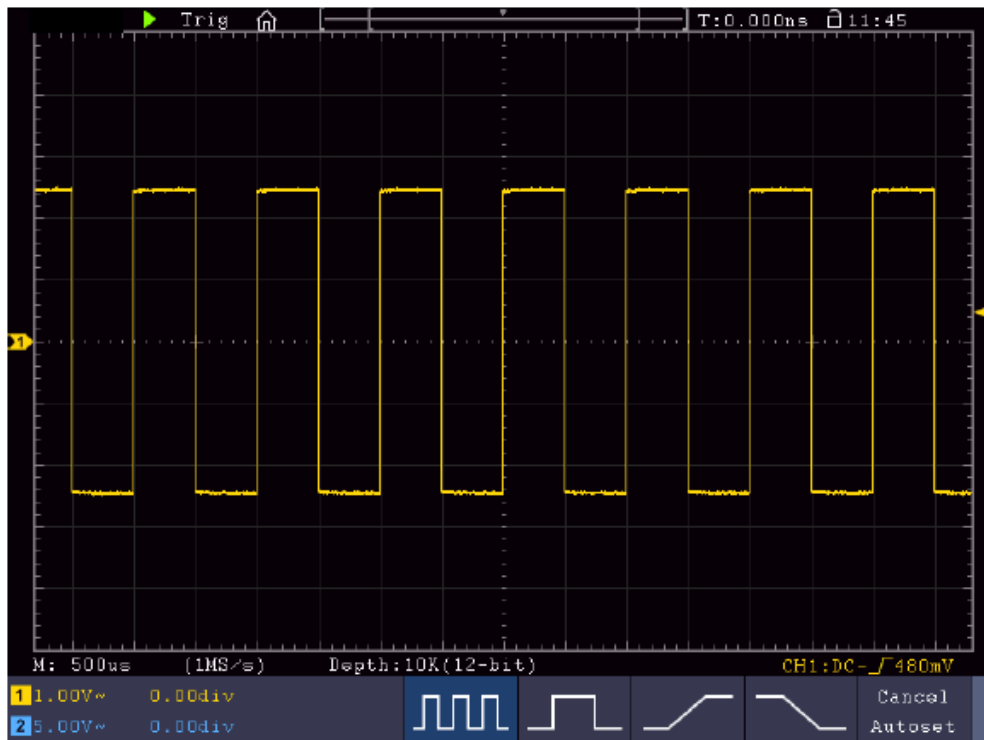
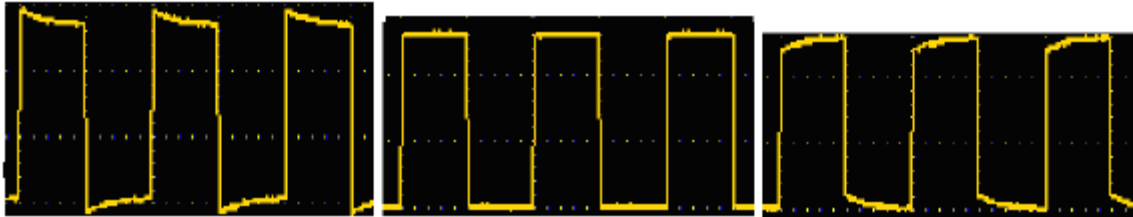

Figure 3.0 Display of the compensation square wave signal

5.2 Probe compensation

The first time you connect the probe to an input channel, you must match the probe to the input channel. A probe that is not or incorrectly compensated results in measurement errors. Perform the probe compensation as follows:

1. Set the attenuation factor of the probe to 10X in the menu, set the switch on the probe to 10X and connect the probe to channel 1. When using the hook tip, make sure it stays securely attached to the probe. Connect the probe tip to the signal connector of the probe compensator and connect the terminal of the reference cable to the ground terminal of the probe compensator; then press the AUTOSET button.
2. Check the displayed waveforms and adjust the probe until correct compensation is achieved



Overcompensated

Correct compensation

Undercompensated

Abbildung 3.1 Tastkopfkomensation

3. Repeat the procedure if necessary in order to obtain an image that is as even as possible.

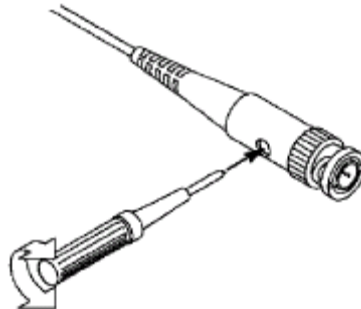

5.3 Setting the probe attenuation factor

The probe has several probe attenuation factors that affect the oscilloscope's vertical scale factor.

If the setted probe attenuation factor should be changed or checked, press the key for the function menu of the respective channel and then the selection key corresponding to the probe until the correct value is displayed.

This setting remains in effect until it is changed again.



Note: The attenuation factor of the probe is in the menu preset to 10x.

Make sure that the value set on the probe's attenuation switch corresponds to the attenuation value set on the oscilloscope.

The values that can be set with the switch on the probe are 1X and 10X (see picture).

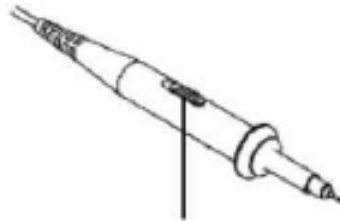

Note: When the attenuation switch is set to 1X, the probe limits the bandwidth of the oscilloscope to 5 MHz. You need to set the switch to 10X if you want to take advantage of the full bandwidth of the oscilloscope.

Safety instruction for using the probe head

The protective ring around the probe head handle prevents unintentional reaching over or slipping and thus contact with any metal parts that may be live (see error! Reference source could not be found).

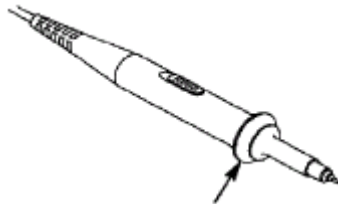

Handle protection



Warning:

To avoid electric shock, you should always keep your fingers behind the safety ring on the probe.

To protect you from electric shock, do not touch any conductive metal part of the probe tip when it is connected to a power source.

Before any measurements are carried out, always first connect the probe to the oscilloscope and then the earth terminal to the housing of the device under test.

5.4 Self - calibration

With the auto-calibration, the oscilloscope can be quickly put in the optimal state for high-precision measurements. You can run this program at any time, but you must do it if the ambient temperature varies by more than 5 ° C. Remove all probes and cables from the input jacks before performing the auto calibration. Press the  symbol, press the “Utility” button, then press the Function area and then press “Adjust”, finally press SelfCal. A window now appears which asks you to press the SelfCal button again to start the self-calibration.

5.5 Introduction to the vertical system

As shown in Figure 3.2, there are some buttons and buttons in the vertical control elements that are used to operate the oscilloscope.

Press one of the channel buttons CH1 or CH2 to open the corresponding channel menu. To deselect the channel, press the button again.

If you want to adjust the vertical position and the vertical scaling of a channel, first press the corresponding channel button to select the desired channel.

Now use the rotary knobs to set the vertical position or the vertical scaling of the channel.

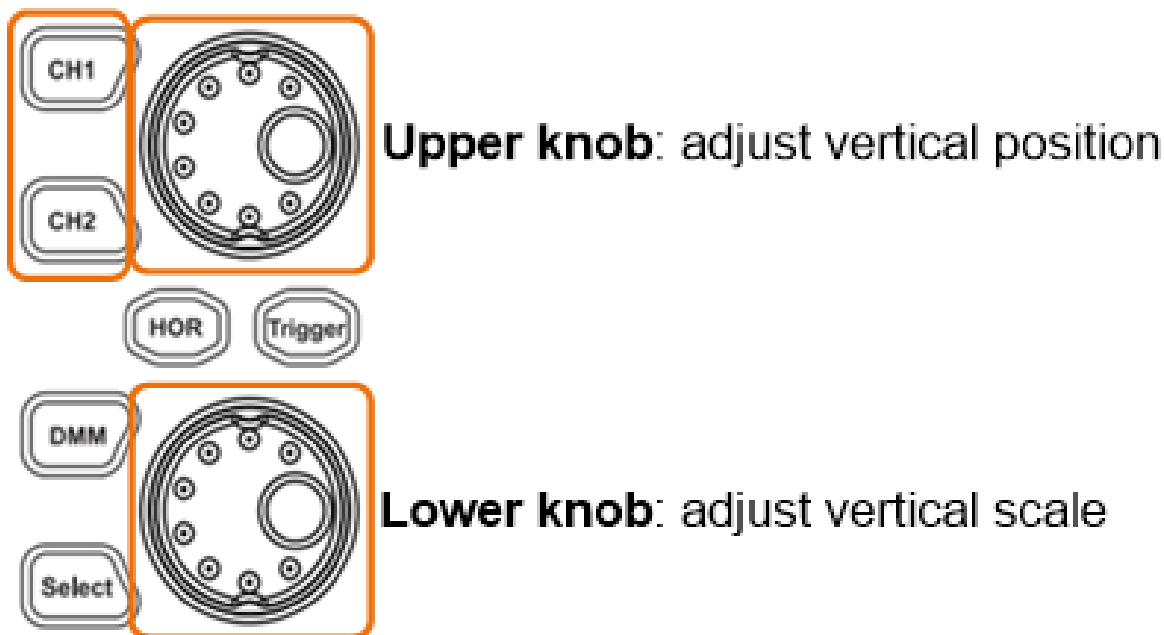

Figure 3.2 Setting the vertical parameters

1. Press the control panel button CH1 or CH2 to select the desired channel
2. When one of the channel buttons is lit, you can use the upper knob to display the selected channel waveform in the center of the waveform window. The top knob controls the vertical display position of the selected channel waveform. When the top knob is turned, the pointer of the grounding point of the selected channel is moved to move up and down the waveform and the position report in the center of the screen changes accordingly.
3. You can change the vertical scale setting. You can read the resulting status information on the display. Use the information in the status bar at the bottom of the waveform window to determine the vertical scaling factor of the channel. Turn the lower knob and change the "Vertical Scaling Factor (Voltage Division)" of the selected channel. The display shows that the scaling factor of the selected channel has been changed accordingly in the status bar

5.6 Introduction to the horizontal system

As shown in Figure 3.3, there is a button and two buttons in the horizontal control elements, which are used to operate the oscilloscope. The following steps explain how the horizontal settings are made.

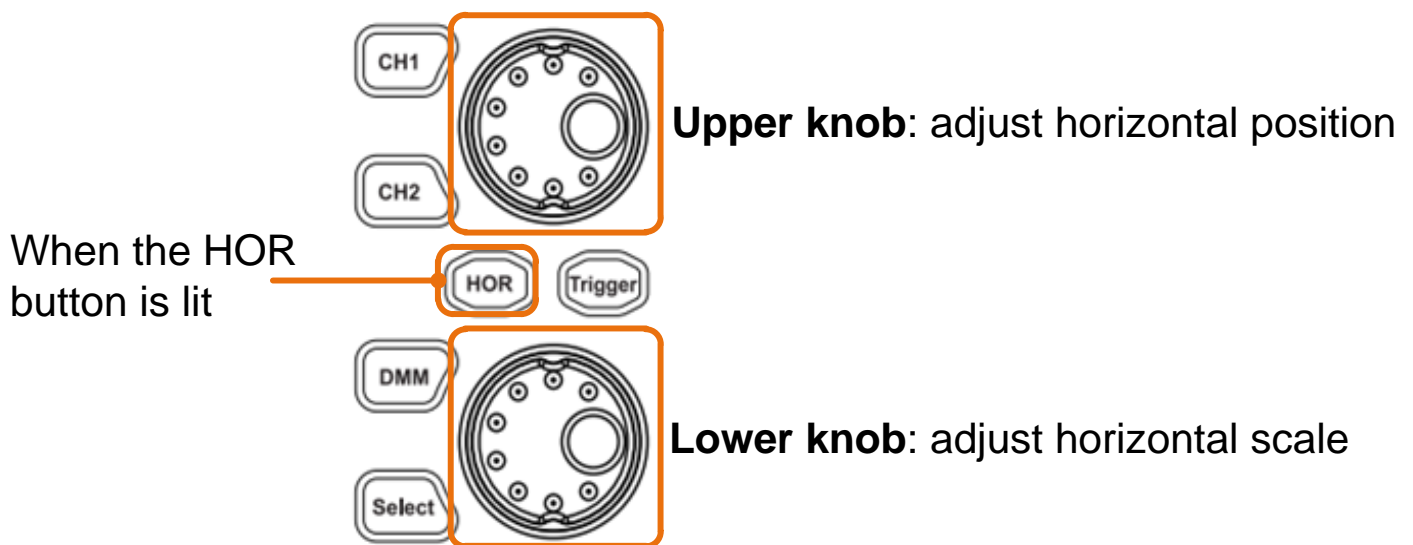

Figure 3.3 Setting the horizontal parameters

1. With the HOR button lit, press the HOR button to toggle between normal mode and wave zoom mode.
2. With the HOR button lit, rotate the lower knob to change the horizontal timebase setting and observe the resulting change in status information. Rotate the lower knob to change the horizontal time base. It can be seen that the horizontal time base displayed in the status bar changes accordingly.
3. When the HOR button is lit, use the upper knob to adjust the horizontal position of the signal in the waveform window. The upper knob is used to control the trigger offset of the signal or for other special applications. When used to trigger the shift, the waveform can be observed to move horizontally as the top knob is turned. By pressing the upper rotary knob, it is possible to reset the set offset to 0.

5.7 Introduction to the trigger system

As shown in Figure 3.4, it is possible to manage the trigger control using a button and a rotary knob. The following steps explain how the trigger settings are made.

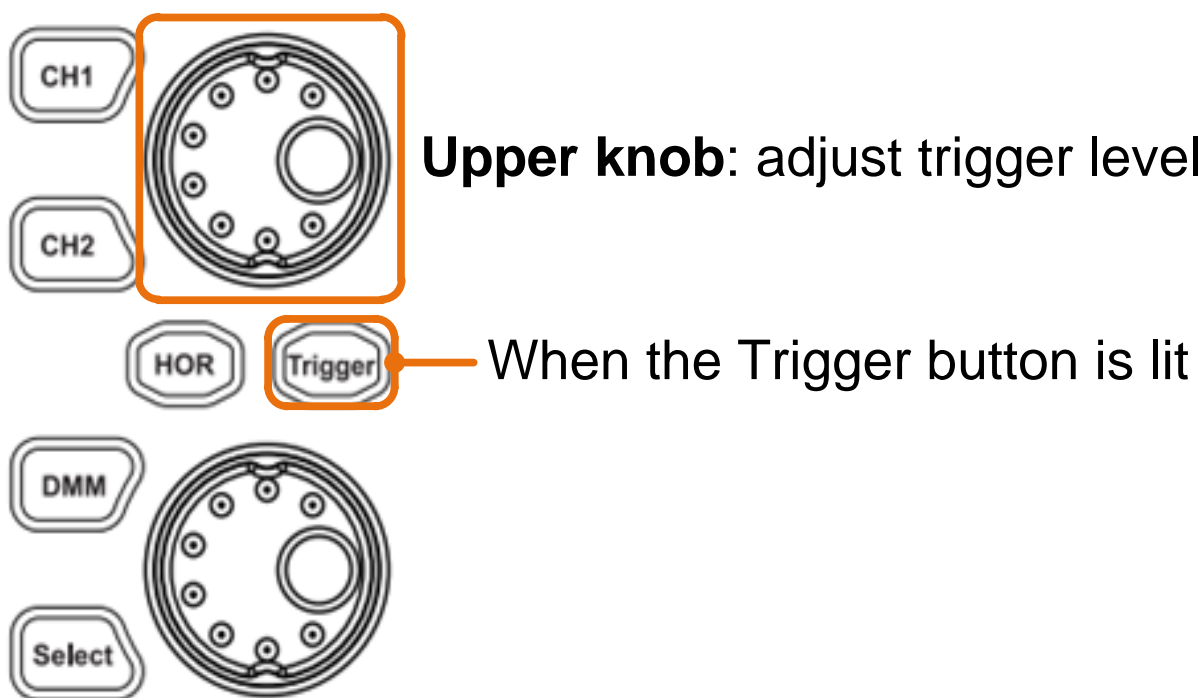





Figure 3.4 Setting the trigger

Press the  symbol and open the trigger menu. In this submenu it is possible to adjust the signal by setting the trigger for the display.

1. Press the  symbol and open the trigger menu. In this submenu it is possible to adjust the signal by setting the trigger for the display.
2. To set the trigger, press the trigger button that it lights up. You are now able to adjust the trigger level of the previously selected channel using the upper rotary knob for the required display.

5.8 Introduction to the touchscreen operation

The oscilloscope can be controlled and adjusted using the push buttons and rotary knobs. But it is also possible to make the respective setting using the touchscreen.

A symbol is permanently displayed in the upper right corner of the display, which shows whether the touchscreen is locked or available ( or ). When the lock is open, you can adjust the settings using the touchscreen. When it is closed, no settings can be made via the touchscreen. Briefly press the symbol to lock or unlock the touchscreen.

The following explains each of the oscilloscope displays:

5.8.1 Change menu

To change menu options, press the area of the menu item to be changed. Touch the corresponding key to switch, see Figure 3.5:

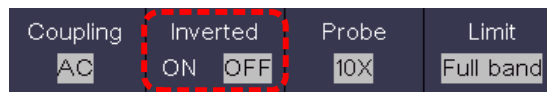

Press repeatedly to switch the options

Figure 3.5 Menu options

5.8.2 Value setting in the menu

use the crosshairs to set the desired measuring rate of the measured value (Figure 3.6):

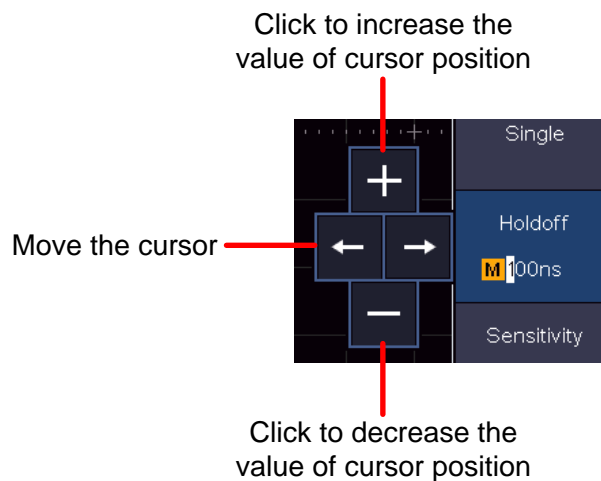

Figure 3.6 Cursor for setting the measuring rate

5.8.3 Calling up the main menu

To call up the main menu, press the symbol in the lower right corner of the screen (🏠). The menu is shown in Figure 3.7.

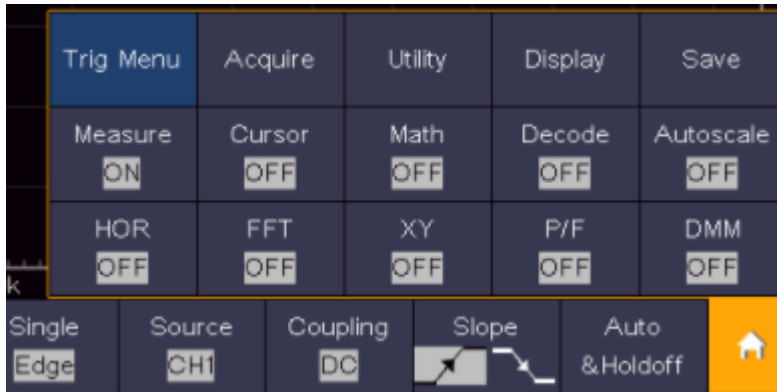
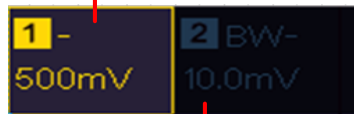

Figure 3.7 Main menu

5.8.4 Selection of the active channel

The available channels are displayed in the lower left corner. By activating the respective channels it is possible to activate or deactivate them. Each active channel is illuminated on the button. When a channel is deactivated, the associated button is darkened (see Figure 3.8).

Channel is on and selected



Channel is off

Figure 3.8 Display of the channels

5.8.5 Adjustment of the horizontal and vertical

By simply pressing the touchscreen on the left-hand side, the arrow keys appear for setting the horizontal and vertical of the selected channel. By pressing the free area of the touchscreen again, the arrows are hidden. In order to be able to make fine adjustments, press directly on the P in the arrow.

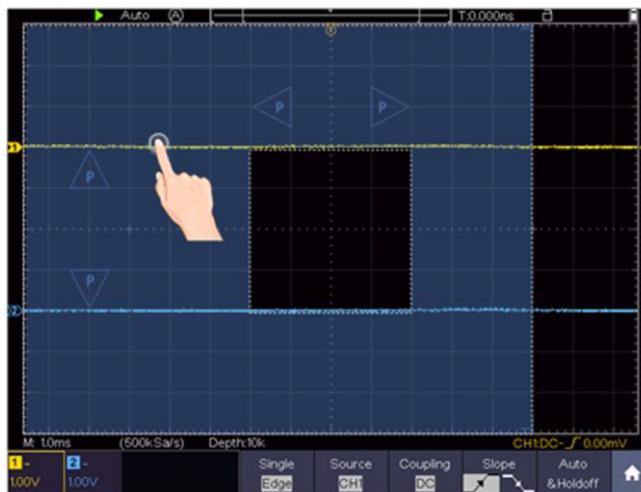

Figure 3.9 Adjustment of the horizontal and vertical

To make fine adjustments, press the P in the arrow directly (see Figure 3.10)



Figure 3.10 Fine adjustment

5.8.6 Setting the trigger level

To adjust the trigger level of the channel, press the free area on the right of the touchscreen. Two arrows appear with which you are now able to change the trigger value (see Figure 3.11).

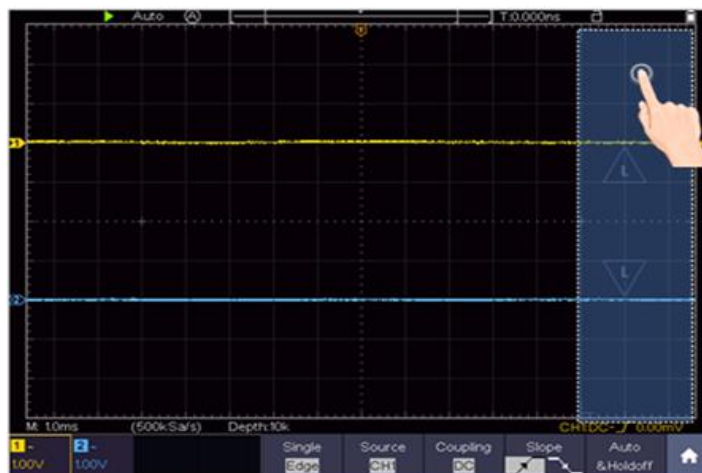

Figure 3.11 Setting the trigger

5.8.7 Setting the time base and voltage division

To set the time base and the voltage division using the touchscreen, press in the middle of the touchscreen and arrows appear for setting the values. The time base or the voltage division is set by simply pressing the arrows (see Figure 3.12).

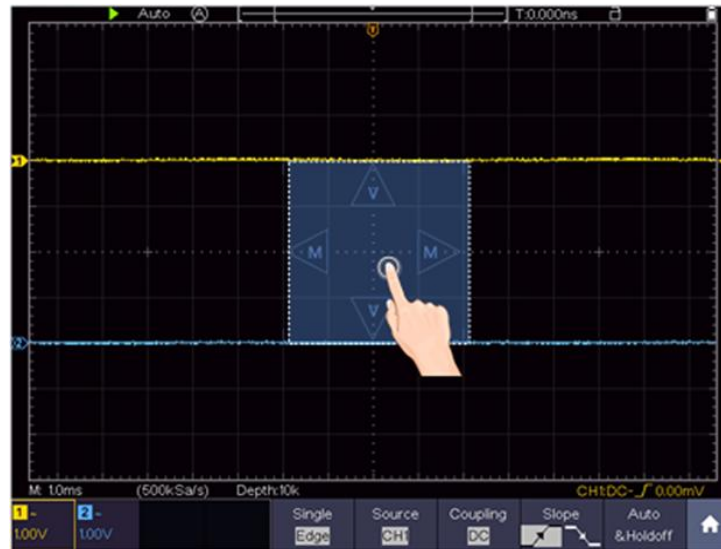
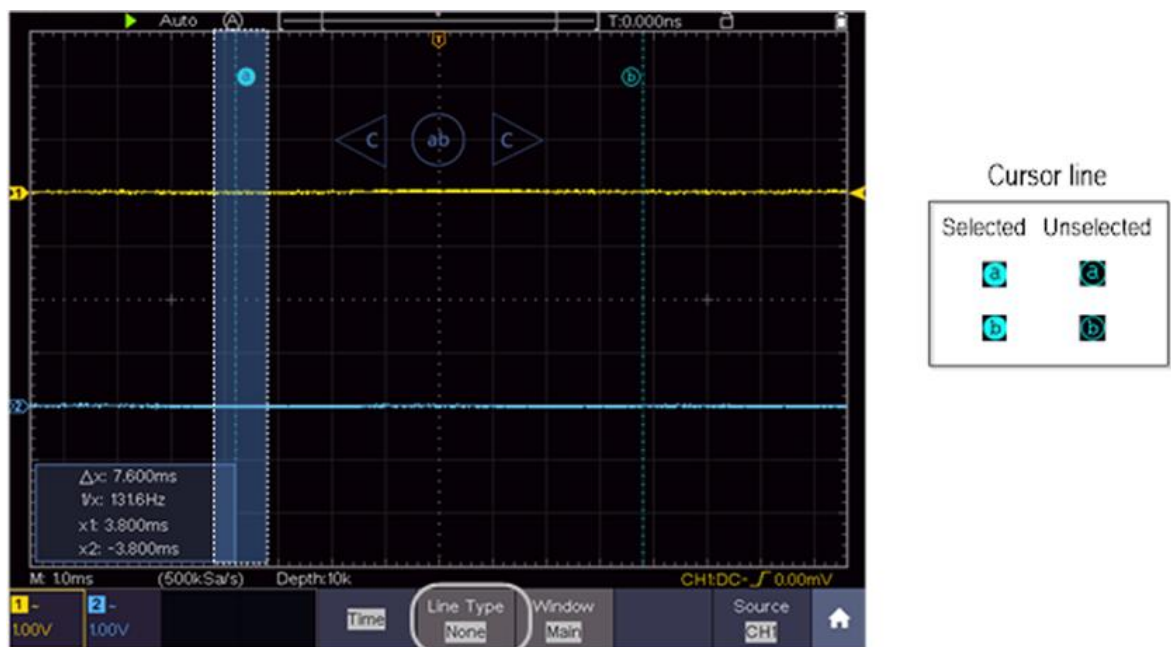

Figure 3.12 Time base and voltage divider

5.8.8 Measurements using the cursor

You are able to determine a recorded current value with the cursor. To do this, press the menu key (see Accessing the main menu) and switch on the cursor. Now, as in Figure 3.13, the option of setting two cursor lines to the measured value appears.



Cursor line	
Selected	Unselected

Switch horizontal or vertical lines
If vertical lines are selected, drag up and down.

Figure 3.13 Measurements using the cursor

6. User Instructions (for advanced users)

In the previous paragraphs, the user has already been familiarized with the basic functions of the functional areas, buttons and knobs of the oscilloscope. Based on the introduction of the previous chapters, the user should already have gained initial knowledge about changing the oscilloscope settings, selecting and evaluating the status bars and general operation.

The following chapters cover the following subject areas:

- **Set the vertical system**
- **Set the horizontal system**
- **Set the trigger system**
- **Carry out sampling settings**
- **Implementation of the auxiliary system**
- **Set the display system**
- **Save and recall waveforms**
- **Record and playback waveforms**
- **Clone and recall a waveform**
- **Supporting system settings**
- **Perform automatic measurements**
- **Setting of automatic measurements**
- **Perform cursor measurements**
- **Using the math function**
- **Use the autoscale function**
- **Use the executing buttons**

It is recommended that you read this chapter carefully in order to be able to use the various measurement functions and other operating methods of the touchscreen oscilloscopes.

6.1 Set the vertical system

The VERTICAL functions include 2 menu buttons such as CH1 ~ CH2 (2CH models) and CH1 ~ CH 4 (4 CH Models) as well as 2 rotary controls for vertical and horizontal setting, to be set for each measuring channel.

Settings CH1 ~ CH2, CH1 ~ CH4

Each channel has an independent vertical menu with functions based on this channel.

Activate / deactivate waveform display

Pressing the CH1 ~ CH2, CH1 ~ CH4 buttons has the following effect:

- If the waveform is switched off, it is switched on and the channel menu is displayed.
- If the waveform is already switched on, the channel menu is also displayed.
- If the waveform is already switched on and the channel menu is displayed, switch the waveform and the channel menu off again with this action

Function menu	Settings		Description
Coupling	DC		Pass both AC and DC components of the input signal.
	AC		Blocks the DC component in the input signal
	GROUND		Disconnect the input signal.
Inverted	On		Display inverted waveform
	Off		Display original waveform
Probe	Attenuation	0.001X to 1000X	Select a attenuation factor that corresponds to the probe in order to obtain a correct representation of the vertical scale factor.
	Current measurement	Yes No	If you are measuring current by probing the voltage drop across a resistor, choose Yes
	A/V (mA/V) V/A (mV/A)		Click + or - to set the Amps/Volts ratio. The range is 100 mA/V - 1 KA/V Amps/Volts ratio = 1/Resistor value Volts/Amp ratio is automatically calculated
Limit	Full band		Full bandwidth
	20M		Limits the channel bandwidth to 20 MHz to reduce visible noise

6.1.1 Setting the channel coupling

As an example, let's take a square wave signal on channel 1 that contains a DC bias. Proceed as follows:

1. Press the CH 1 button to access the CH 1 menu
2. Press pairing in the channel menu
3. Select DC to view the DC and AC components of the signal
4. Select AC to display the AC components of the signal

6.1.2 Setting the probe attenuation

For correct measurement results, the settings of the attenuation factor in the operating menu of the channel should always correspond to those of the probe (probe compensation page 15). If the attenuation factor of the probe is 1: 1, the setting for the input channel should also be X1.

Proceed as follows, e.g. to set a attenuation factor of 10: 1 for channel 1:

1. Press the CH 1 button to enter the menu
2. Select the Sensor function. After that select the attenuation factor 10x on the left side of the display

6.1.3 Current measurement

In order to perform a current measurement with the oscilloscope, you have to perform the voltage drop on a resistor / shunt. In the following example, the current is measured by the voltage drop across a resistor that has 1 Ω :

1. Press the CH 1 button to enter the menu
2. Now select the Probe function and switch from No to Yes in the Measurement Current selection on the right. Now the setting for the V / A display appears. This shows the respective display ratio of current to voltage. You can change this ratio by pressing the button using the arrow keys and the + and - keys

6.1.4 Invert a waveform

The inverted waveform rotates the displayed signal 180 degrees from the phase of the ground potential.

1. To invert the waveform, press the CH1 key
2. Press the Invert button to toggle between the On and Off settings

6.1.5 Setting the bandwidth limit

When the high frequency components of a waveform are not important for your analysis, bandwidth limiting can be used to suppress frequencies above 20 MHz.

Proceed as follows:

1. Press the CH 1 button to enter the menu
2. Select the limit value function
3. Now select the 20M function to only display frequencies up to 20 MHz
4. Select the Full Band function to measure all frequencies up to the maximum bandwidth

6.2 Set the horizontal system

To set the horizontal system, the HOR function key and the two rotary knobs are used as follows:

- Press the HOR key to activate the horizontal setting
- With the upper rotary knob you are now able to determine the horizontal position of the respective channels
- The sampling rate of the respective channel is set with the lower rotary knob
- Press the HOR key again to activate the waveform zoom function

6.3 Waveform zoom function

Press the horizontal HOR button twice and enter the horizontal zoom mode for the waveform. The upper part of the display shows the main window and the lower part the horizontal zoomed window. The horizontal zoom window is the horizontal enlarged part of the selected area in the main window.

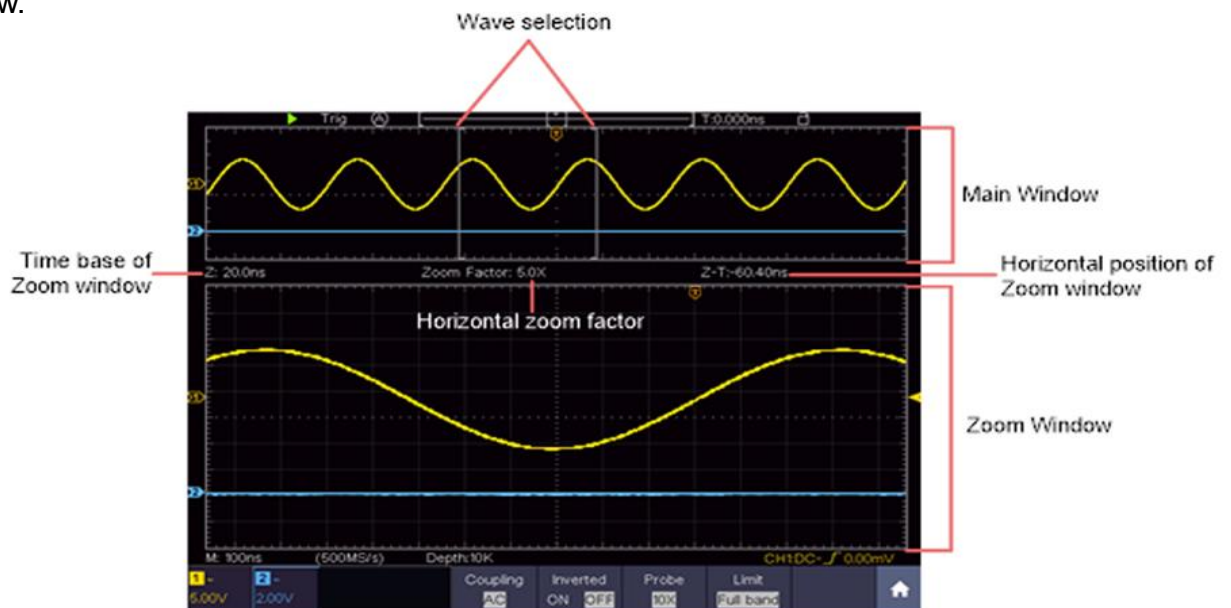

Figure 4.0 Waveform zoom function

6.4 Operation of the function menu

The operating area of the function menu comprises 13 function menu keys: **Trig Menu, Acquire, Utility, Autoscale, Save, Measure, Cursor, Math, Decode, HOR, FFT, XY, P / F, DMM** as well as 5 immediate selection keys: **Autoset, Run / Stop, Single, Copy, default**.

6.5 Set the trigger system

The trigger determines when the oscilloscope begins acquiring data and displaying the waveform. Once properly set, the trigger can convert a fluctuating reading into a meaningful waveform.

When the oscilloscope begins acquiring data, it records enough data to plot the waveform to the left of the trigger point. The oscilloscope continues to acquire data while it waits for a trigger condition. When a trigger is detected, the device continues to record enough data to display the waveform to the right of the trigger point.

The trigger control area consists of 1 rotary knob and 2 menu buttons.

6.5.1 Single trigger

Trigger control

The device provides four types of triggers: single trigger (single), logic trigger and bus trigger. Each trigger type has different submenus.

There are two ways to get into the trigger mode:

Button operation: Press Menu in the trigger field to open the trigger menu. With H1 you can then select the extended trigger menu, which you can scroll (turn) and select (press) with the **M** multipurpose rotary knob.

Touchscreen operation: Press the house symbol  to open the touch menu. Select Trig Menu and then the trigger (Single, Logic, Bus) in the lower menu. The trigger type can then be selected under Type in the right image menu.

Single: Uses a single trigger to display a stable waveform on both channels.

Logic trigger: Triggers a signal according to the conditions of the logic ratio

Bus trigger: Sets bus timing triggers

Trigger description

The single, logic and bus trigger menus are described below:

Edge trigger: Occurs when the trigger input runs through a specific voltage level with the specified slope.

Video trigger: Trigger on fields or lines for a standard video signal

Slope trigger: The oscilloscope begins to trigger according to the rate of rise or fall of the signal

Pulse trigger: Finds impulses with certain widths

Runt trigger: Trigger pulses that run through one trigger level but not the other trigger level.







Window trigger: Gives a high trigger level and a low trigger level. The oscilloscope triggers when the input signal passes through the high or low trigger level.

Timeout trigger: The oscilloscope triggers when the time interval from the time of the rising edge (or falling edge) due to the trigger level if the neighboring falling edge (or the rising edge) due to the trigger level is greater than the set timeout time.

Nth Edge trigger: The oscilloscope triggers on the Nth edge that appears on the specified idle time.

6.5.2 Edge trigger

An edge trigger occurs at the input signal trigger threshold. Select the Edge trigger mode to trigger on the rising or falling edge of the signal.

Menu	Settings	Description
Single	Edge	Set vertical channel trigger type as edge trigger
Source	CH1	Channel 1 as trigger signal.
	CH2	Channel 2 as trigger signal.
	CH3	Channel 3 as trigger signal.
	CH4	Channel 4 as trigger signal.
Coupling	AC	Block the direct current component.
	DC	Allow all component pass.
	HF	Block the high-frequency signal, only low-frequency component pass
Slope		Trigger on rising edge
		Trigger on falling edge
Modus & Holdoff	Auto	Acquire waveform even no trigger occurs
	Normal	Acquire waveform when trigger occurs
	Single	When trigger occurs, acquire one waveform then stop
	Holdoff	100 ns - 10 s, click  or  to set time interval before another trigger occur, click   to move cursor to choose which digit to be set.
	Sensitivity	Set the trigger sensitivity.

Trigger level:

The trigger level indicates vertical trig position of the channel, turn the trig level knob or slide on the touch screen upward and downward to move trigger level, during setting, an orange red dotted line displays to show trig position, and the value of trigger level changes at the right corner, after setting, dotted line disappears.

6.5.3 Video trigger

Select the video mode to trigger on video fields or video lines of NTSC, PAL or SECAM standard video signals. In the video trigger mode, the setting information is displayed at the bottom right of the screen, e.g: **CH1:ALL** indicates that the video trigger has been selected on CH1 and the sync type "even".

Video trigger menu:

Menu	Settings	Description
Trigger mode	Video	Set vertical channel trigger type as video trigger
Source	CH1 CH2 CH3 CH4	Select CH1 as the trigger source Select CH2 as the trigger source Select CH3 as the trigger source Select CH4 as the trigger source
Mode	NTSC PAL SECAM	Select video modulation
Sync	Line Field Odd Even Line NO.	Synchronic trigger in video line Synchronic trigger in video field Synchronic trigger in video odd filed Synchronic trigger in video even field Synchronic trigger in designed video line, click + or - to set the line number
Mode Holdoff	Auto	Acquire waveform even no trigger occurred

6.5.4 Pulse width trigger

Pulse trigger occurs according to the width of pulse. The abnormal signals can be detected through setting up the pulse width condition.

In Pulse Width Trigger mode, the trigger setting information is displayed on bottom right of the screen, for example **CH1:DC-0.00mV**, indicates that trigger type is pulse width, trigger source is CH1, coupling is DC, polarity is positive, and trigger level is 0.00mV.

Pulse trigger menü:

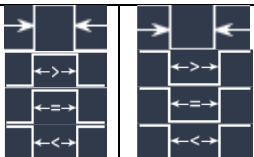
Menu	Settings	Description
Trigger mode	Pulse	Set vertical channel trigger type as pulse trigger.
Source	CH1 CH2 CH3 CH4	Select CH1 as the trigger source Select CH2 as the trigger source Select CH3 as the trigger source Select CH4 as the trigger source
Coupling	AC DC	Not allow DC portion to pass. Allow all portion pass.
When		Choose the polarity Select pulse width condition and click + or - to set time, click ← → to move cursor to choose which digit to be set.
Mode Holdoff	Auto Normal Single Holdoff Sensitivity	Acquire waveform even no trigger occurred Acquire waveform when trigger occurred When trigger occurs, acquire one waveform then stop 100 ns - 10 s, click + or - to set time interval before another trigger occur, click ← → to move cursor to choose which digit to be set Set the trigger sensitivity

6.5.5 Slope trigger

The slope mode allows the oscilloscope to trigger on the rising / falling edge of a signal within a specified period of time. In the slope trigger mode, the setting information is shown on the lower right edge of the screen, e.g: **CH1:Δ 0.00mV** indicates that the slope trigger has been selected on CH1, slope increasing and the difference between the up-level and low-level threshold value is 0.00mV.

Slope trigger menu list:

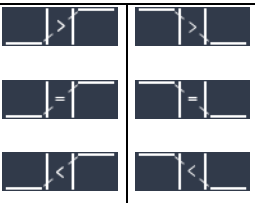
Menu	Setting	Description
Single	Slope	Set vertical channel trigger type as slope trigger.
Source	CH1 CH2 CH3 CH4	Select CH1 as the trigger source Select CH2 as the trigger source Select CH3 as the trigger source Select CH4 as the trigger source
When	slope 	Slope selecting
		Set slope condition; click + or - to set slope time, click ← → to move cursor to choose which digit to be set.
Threshold & SlewRate	High level Low level Slew rate	Click + or - to set the High level upper limit. Click + or - to set Low level lower limit. Slew rate = (High level - Low level) / Settings
Mode	Auto	Acquire waveform even no trigger occurred
	Normal	Acquire waveform when trigger occurred
	Single	When trigger occurs, acquire one waveform then stop
Holdoff	Holdoff	100 ns – 10 s, click + or - to set time interval before another trigger occur, click ← → to move cursor to choose which digit to be set.





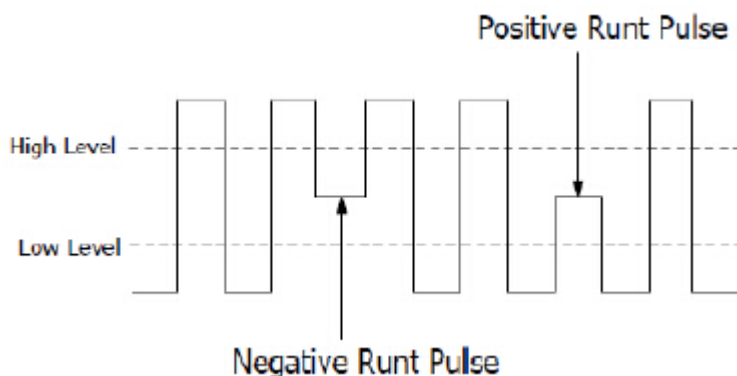



6.5.6 Runt trigger

The runt trigger records pulses that run through one trigger level, but not through another, as shown in the graphic.



In runt trigger mode, the setting information is shown at the bottom right of the screen, e.g: **CH1: Δ 0.00mV** indicates that the runt trigger on CH1 with positive polarity has been selected and the difference between the up-level and low-level threshold value is 0.00mV.

Runt trigger menu:









Menu	Settings	Description
Trigger Mode	Runt	Set vertical channel trigger type as runt trigger.
Source	CH1 CH2 CH3 CH4	Select CH1 as the trigger source Select CH2 as the trigger source Select CH3 as the trigger source Select CH4 as the trigger source
Threshold	Up Level Low Level	Click + or - to set the up level threshold. Click + or - to set the low level threshold.
Condition	Polarity  	Positive Polarity, the oscilloscope triggers on the positive runt pulse. Negative Polarity, the oscilloscope triggers on the negative runt pulse.
	     	Click + or - to set pulse width, click ← → to move cursor to choose which digit to be set. Trigger when runt pulse is greater than the set pulse width. Trigger when runt pulse equals to the set pulse width. Trigger when runt pulse is lower than the set pulse width.
Mode	Auto Normal Single	Acquire waveform even no trigger occurred Acquire waveform when trigger occurred When trigger occurs, acquire one waveform then stop
Holdoff	Holdoff	100 ns - 10 s, click + or - to set time interval before another trigger occur, click ← → to move cursor to choose which digit to be set.

6.5.7 Window trigger

Provide a high trigger level and low trigger level, the oscilloscope triggers when the input signal passes through the high trigger level or the low trigger level.

In Windows Trigger mode, the trigger setting information is displayed on bottom right of the screen, for example, **CH1 : Δ 0.00mV**, indicates that trigger type is windows, trigger source is CH1, polarity is positive, 0.00mV the differential between up level and low level threshold.

Fenster Trigger Menü:

Menu	Settings	Description
Trigger Mode	Window	Set vertical channel trigger type as Windows trigger.
Source	CH1 CH2 CH3 CH4	Select CH1 as the trigger source Select CH2 as the trigger source Select CH3 as the trigger source Select CH4 as the trigger source
Threshold	Up Level Low Level	Click + or - to set the up level threshold. Click + or - to set the low level threshold.
Condition	Polarity  	Positive Polarity, the oscilloscope triggers on the positive Windows pulse. Negative Polarity, the oscilloscope triggers on the negative Windows pulse.
	 	Enter: Triggers when the trigger signal enters the specified trigger level range.
	 	Exit: Triggers when the trigger signal exits the specified trigger level range.
	 	Time: Specify the hold time of the input signal after entering the specified trigger level. The oscilloscope triggers when the accumulated hold time is greater than the windows time. Available range is 30ns-10s, default 100ns.
Mode Holdoff	Auto Normal Single Holdoff	Acquire waveform even no trigger occurred Acquire waveform when trigger occurred When trigger occurs, acquire one waveform then stop 100 ns - 10 s, click + or - to set time interval before another trigger occur, click ← → to move cursor to choose which digit to be set.

6.5.8 Timeout trigger

The oscilloscope triggers when the time interval from when the rising edge (or the falling edge) passes through the trigger level to when the neighbouring falling edge (or the rising edge) passes through the trigger level is greater than the timeout time set.

In Timeout Trigger mode, the trigger setting information is displayed on bottom right of the screen, for example, **CH1:  -150V**, indicates that trigger type is Timeout, trigger source is CH1, edge is positive, 0.00mV is up level or low level threshold.

Timeout trigger menu:

Menu	Settings	Description
Trigger Mode	Timeout	Set vertical channel trigger type as Timeout trigger.
Source	CH1 CH2 CH3 CH4	Select CH1 as the trigger source Select CH2 as the trigger source Select CH3 as the trigger source Select CH4 as the trigger source
Polarity	Edge 	Start timing when the rising edge of the input signal passes through the trigger level. Start timing when the falling edge of the input signal passes through the trigger level.
Configuration	Idle Time	Set idle time. Idle time means the minimum time of idle clock before searching data that can meet trigger conditions. Available range is 30ns-10s, default 100ns.
Mode	Auto Normal Single	Acquire waveform even no trigger occurred Acquire waveform when trigger occurred When trigger occurs, acquire one waveform then stop
Holdoff	Holdoff	100 ns - 10 s, click + or - to set time interval before another trigger occur, click ← → to move cursor to choose which digit to be set.
	Sensitivity	Set the trigger sensitivity.

6.5.9 Nth edge trigger

The oscilloscope triggers on the Nth edge that appears on the specified idle time. As figure shown below, the oscilloscope should trigger on the second falling edge after the specified idle time and the idle time should be set to $P1/P2/P3/P4 < \text{Idle Time} < M$. Wherein, M, P1, P2, P3 and P4 are positive or negative pulse width participating in the counting.

In Nth Edge Trigger mode, the trigger setting information is displayed on bottom right of the screen, for example, **CH1:Nth0.00mV**, indicates that trigger type is Nth Edge, trigger source is CH1, -150V is up level or low level threshold.

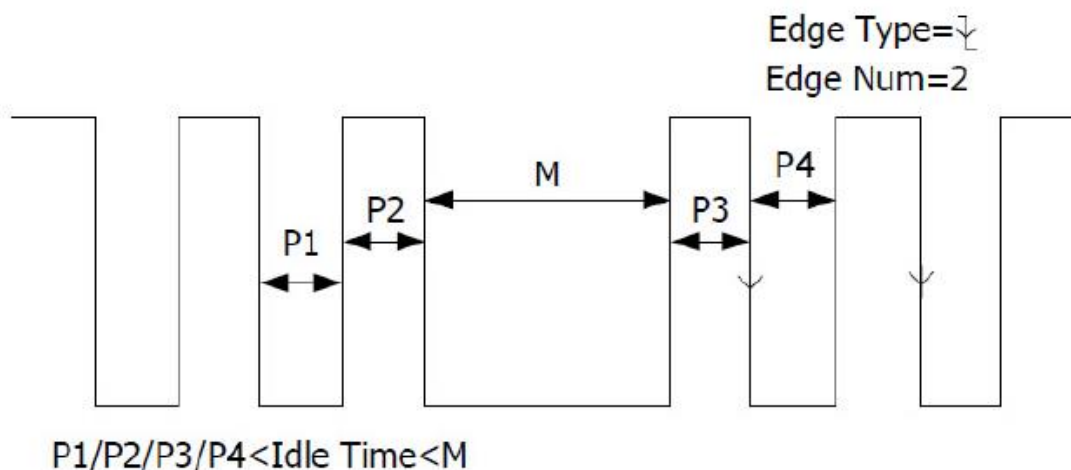

Nth trigger menu:

Menu	Settings	Description
Trigger Mode	Nth Edge	Set vertical channel trigger type as Nth Edge trigger.
Source	CH1 CH2 CH3 CH4	Select CH1 as the trigger source Select CH2 as the trigger source Select CH3 as the trigger source Select CH4 as the trigger source
Polarity	Edge 	Trigger on the rising edge of the input signal when voltage level meets the specified trigger level. Trigger on the falling edge of the input signal when voltage level meets the specified trigger level.
Configuration	Idle Time	Set idle time before the edge counting in Nth Edge Trigger. Click + or - to set idle time, click ← → to move cursor to choose which digit to be set. Available range is 30ns-10s, default 100ns.
	Edge Num	Set the edge number value of "N" in Nth Edge trigger.
Mode	Auto Normal Single	Acquire waveform even no trigger occurred Acquire waveform when trigger occurred When trigger occurs, acquire one waveform then stop
Holdoff	Holdoff	100 ns - 10 s, click + or - to set time interval before another trigger occur, click ← → to move cursor to choose which digit to be set.
	Sensitivity	Set the trigger sensitivity.

6.5.10 Logic trigger

Trigger according to logic relation.

In Logic Trigger mode, the trigger setting information is displayed on bottom right of the screen, for example, **CH1>HHHH>CH4 => CH1: H 0.00mV**, indicates that trigger type is Logic, logic mode is AND, CH1 high level and trigger level is 0.00mV.

Logic trigger menu:

Menu	Settings	Description
Trigger Mode	Logic	Set vertical channel trigger type as Logic trigger.
Logic Mode	AND OR XNOR XOR	Set logic mode as AND. Set logic mode as OR. Set logic mode as XNOR. Set logic mode as XOR.
Input Mode	CH1 CH2 CH3 CH4	Set CH1 as High Level, Low level, high or low level, Rise and Fall. Set CH2 as High Level, Low level, high or low level, Rise and Fall. Set CH3 as High Level, Low level, high or low level, Rise and Fall. Set CH4 as High Level, Low level, high or low level, Rise and Fall. Note : When input mode of one channel is set as Rise or Fall, the other channel could not be set as Rise and Fall at the same time.
Out Mode	Goes True Goes False Is True> Is True< Is True=	Trigger when condition turns True from False. Trigger when condition turns False from True. Trigger when the time of true condition is greater than the set time Trigger when the time of true condition is equal to the set time Trigger when the time of true condition is lower than the set time
Mode Holdoff	Auto Normal Single Holdoff Sensitivity	Acquire waveform even no trigger occurred Acquire waveform when trigger occurred When trigger occurs, acquire one waveform then stop 100 ns - 10 s, click + or - to set time interval before another trigger occur, click ← → to move cursor to choose which digit to be set. Set the trigger sensitivity.

Note: If a channel is set as “Rise” or “Fall”, the other channel cannot be set as “Rise” or “Fall” at the same time

6.5.11 Bus trigger

1. SPI

Trigger on the specified data when the timeout condition is met. When using SPI trigger, you need to specify the SCL and SDA data sources.

In SPI bus trigger mode, the trigger setting information is displayed on bottom right of the screen, for example, **SPI CH1:0.00mV**, indicates that trigger type is SPI, CH1 trigger level is 0.00mV.

Menu	Settings	Description
Bus Type	SPI	Vertikaler Bus-Typ als SPI-Triggerung festlegen
Source	SCL	Set SCL
Timeout	Time out	Set the minimum time that SCL must be idle, that is a period of SCL, available range 100ns-10s. Time out means SCL keeps idle for a specified time before oscilloscope starts to search for the data (SDA) on which to trigger. Click + or - to set time out, click ← → to move cursor to choose which digit to be set.
ClockEdge & Data	Clock Edge	Set Clock Edge as rising edge or falling edge. Means sample the SDA data on the rising edge or falling edge of the clock.
		
	Data Bits	Set the number of bits of the serial data character string. It can be set to any integer between 4-32. Click + or - to set Data Bits.
	Current Bits	Set the number of the data bits, ranges from 0-31, click + or - to set Current Bit.
	Data	Set the value of the current data bit as H, L, or X (H or L).
	All Bits	Set all the data bits to be the specified value in Data.
Mode	Auto Normal Single	Acquire waveform even no trigger occurred Acquire waveform when trigger occurred When trigger occurs, acquire one waveform then stop
Holdoff		

2. I2C trigger

The I2C serial bus consists of SCL and SDA. The transmission rate is determined by SCL, and the transmission data is determined by SDA. As shown in below figure, oscilloscope can trigger on the start, restart, stop, ack lost, specific device address or data value, also device address and data value at the same time.

In I2C bus trigger mode, the trigger setting information is displayed on bottom right of the screen, for example, **I2C CH1:0.00mV**, indicates that trigger type is I2C, CH1 trigger level is 0.00mV.

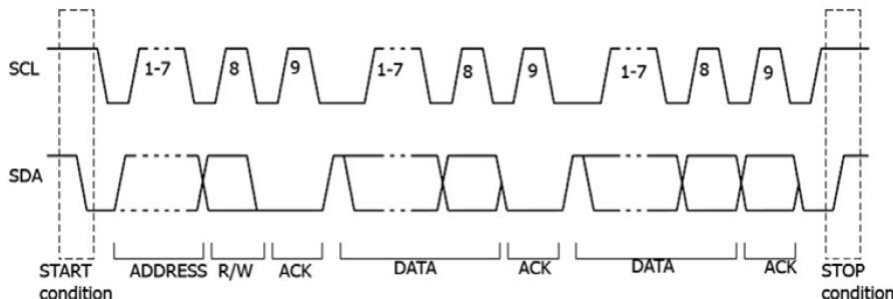

Menu	Settings	Description	
Bus Type	I2C	Set vertical channel bus type as I2C trigger.	
Source	SCL SDA	Set SCL. Set SDA.	
When	Start	Trigger when SDA data transitions from high to low while SCL is high.	
	Restart	When another start condition occurs before a stop condition.	
	Stop	Trigger when SDA data transitions from low to high while SCL is high.	
	Ack Lost	Trigger when SDA data is high during any acknowledgement of SCL clock position.	
	Address	Trigger on the read or write bit when the preset address is met.	
	Adr Format	Addr Bits	Set Address Bits to be "7", "8" or "10".
		Address	Set address according to the preset address bits, address range is 0-127, 0-255, 0-1023 respectively.
		Direction	Set Data Direction to be Write or Read . Note: The set is not available when Address bits is set to "8".
Data	Search for the preset data value on SDA and trigger on the dump edge of SCL of the last bit of the data area.		
Data Format	Byte length	Set data byte length, available range 1-5 bytes. Click + or - to set byte length.	
	Current Bit	Select the data bit, ranges from 0 to (byte length*8 -1).	
	Data	Set data to be H, L, or X (H or L)	
	All Bits	Set all the data bits to be the specified value in Data	
	Addr / Data	Set all the data bits to be the specified value in Data	
Mode	Auto Normal	Acquire waveform even no trigger occurred Acquire waveform when trigger occurred	
Holdoff	Single	When trigger occurs, acquire one waveform then stop	

3. RS232 trigger

RS232 is a serial communication mode used in the data transmission between PCs or between PC and Terminal. A character is transmitted as a frame of data which consist of 1bit start bit, 5-8bits data bits, 1bit check bit and 1-2 stop bits.

In RS232 bus trigger mode, the trigger setting information is displayed on bottom right of the screen, for example, **RS232 CH1:0.00mV**, indicates that trigger type is UART, CH1 trigger level is 0.00mV.



Menu	Settings	Description
Bus Type	RS232	Set vertical channel bus type as RS232 trigger.
Input	Source	CH1 Select CH1 as the trigger source CH2 Select CH2 as the trigger source CH3 Select CH3 as the trigger source CH4 Select CH4 as the trigger source
	Polarity	Normal Select polarity of data transmission as Normal. Inverted Select polarity of data transmission as Inverted.
When	Start	Trigger on the start frame of position. After choosing this condition, press Configure to enter detailed settings.
	Error	Trigger when error frame is detected. After choosing this condition, press Configure to enter detailed settings.
	Chk Error	Trigger when Chk Error is detected. After choosing this condition, press Configure to enter detailed settings.
	Data	Trigger on the last bit of the preset data. After choosing this condition, press Configure to enter detailed settings.
Configuration	Start	Common Baud: click in the left menu to choose common baud. Custom Baud: click + or - choose baud, ranges from 50 to 10,000,000.
	Error	Stop Bit : Select "1" or "2". Parity: Select None, Odd, or Even Common Baud: click in the left menu to choose common baud. Custom Baud: click + or - to choose baud, ranges from 50 to 10,000,000.
	Chk Error	Parity: Select Odd or Even. Common Baud: click in the left menu to choose common baud. Custom Baud: click + or - to choose baud, ranges from 50 to 10,000,000.

	Data	Data Bits: Set as 5, 6, 7, 8 bits. Data : Set data according to data bits, ranges from 0-31, 0-63, 0-127 or 0-255. Common Baud: click in the left menu to choose common baud. Custom Baud: click + or - to choose baud, ranges from 50 to 10,000,000.
Mode	Auto	Acquire waveform even no trigger occurred
Holdoff	Normal	Acquire waveform when trigger occurred
	Single	When trigger occurs, acquire one waveform then stop

7. Sampling Setup

Click  to call up the menu panel. Click the **Acquire** softkey on panel, **Acqu Mode**, **Length**, **PERF Mode**, and **Intrpl** is shown in the bottom menu.

Description of the Acqu Mode menu

Menu		Settings	Description
Acqu Mode	Sample		Normal sampling mode.
	Peak detect		Use to capture maximal and minimal samples. Finding highest and lowest points over adjacent intervals. It is used for the detection of the jamming burr and the possibility of reducing the confusion.
	Average	4,16,64,128	It is used to reduce the random and don't-care noises, with the optional number of averages.
	Refresh Rate	Low	Set the waveform refresh rate, you can turn on this mode when you need to observe a single waveform

Description of the record length menu:

Menu	Settings	Description
Länge	1000	Choose the record length Note: When four channels are turned on, the max record length is 10M; max 20M for two channels; and max 40M for one channel.
	10K	
	100K	
	1M	
	10M	
	20M	
	40M	

Description of the Intrpl menu :

Menu	Settings	Description
Intrpl	Sinx/x	Use sine(x)/x interpolation
	x	Use linear interpolation

Interpolation method is a processing method to connect the sampled points, using some points to calculate the whole appearance of the waveform. Select the appropriate interpolation method according to the actual signal.

Sine(x)/x interpolation: Connect the sampled points with curved lines.

Linear interpolation: Connect the sampled points with straight lines. This method is suitable to rebuild the straight-edged signals, such as square or pulse wave.

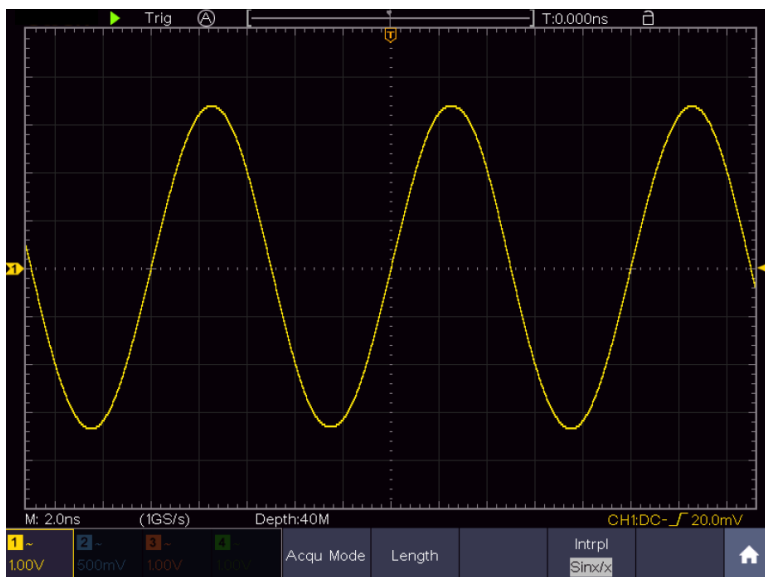

Figure 4.1 Sine(x)/x interpolation

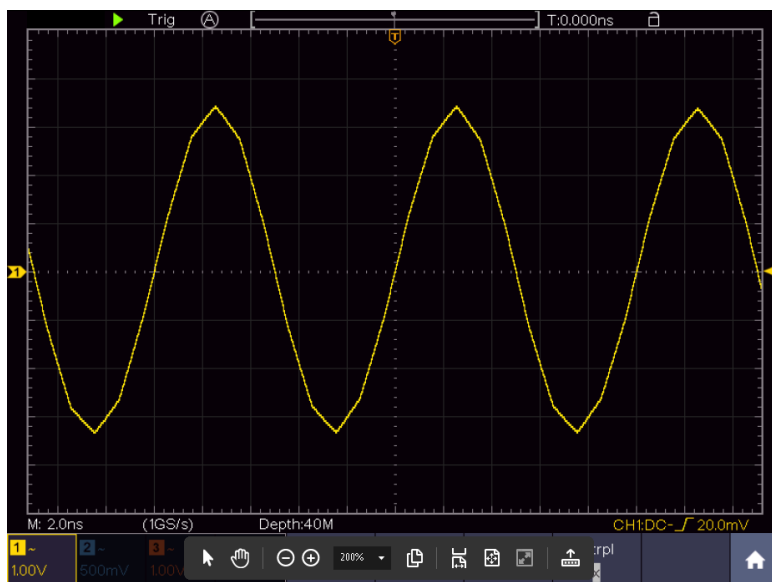



Figure 4.2 Linear interpolation

8. Implementation of the function setting for the auxiliary system

Configuration

Click  to call up the menu panel. Click the Utility softkey on panel, select Function in the bottom menu, select Configure in the left menu.

The description of **Configure Menu** is shown as the follows:

Menu	Settings	Description
Language		Choose the display language of the operating system.
Set time	Display ON OFF	On/Off the date display
	Hour/ minute	Setting Hour / Minute
	Day / Month	Setting Day / Month
	Year	Setting Year
Keylock		Lock all keys. Unlock method: push HOR button, then push Trigger button, repeat 3 times.
About		Show serial number, version, and checksum

Display

Click  to call up the menu panel. Click the **Utility** softkey on panel, select **Function** in the bottom menu, select **Display** in the left menu

The description of Display Menu is shown as the follows:

Menu	Settings	Description
Backlight	0% - 100%	Adjust the backlight.
Graticule		Select the grid type
Battery	ON OFF	Turn on or off the battery display
Menu time	OFF, 5s – 30s	Set the disappear time of menu

Adjust

Click  to call up the menu panel. Click the **Utility** softkey on panel, select **Function** in the bottom menu, select **Adjust** in the left menu.

Function menu	Description
Self Cal	Carry out the self-calibration procedure.
Default	Call out the factory settings.
ProbeCh.	Check whether probe attenuation is good.

Self - Calibration

The self-calibration procedure can improve the accuracy of the oscilloscope under the ambient temperature to the greatest extent. If the change of the ambient temperature is up to or exceeds 5°C, the self-calibration procedure should be executed to obtain the highest level of accuracy.

Before executing the self-calibration procedure, disconnect all probes or wires from the input connector. Click  to call up the menu panel. Click the **Utility** softkey on panel, select **Function** in the bottom menu, the function menu will display at the left, select **Adjust**. If everything is ready, select **Self Cal** in the bottom menu to enter the self-calibration procedure of the instrument.

Probe checking

To check whether probe attenuation is good. The results contain three circumstances: Overflow compensation, Good compensation, Inadequate compensation. According to the checking result, users can adjust probe attenuation to the best. Operation steps are as follows:

1. Connect the probe to CH1, adjust the probe attenuation to the maximum.
2. Click  to call up the menu panel. Click the Utility softkey on panel, select **Function** in the bottom menu, select **Adjust** in the left menu.
3. Select **ProbeCh.** in the bottom menu, tips about probe checking shows on the screen. Select **ProbeCh.** again to begin probe checking and the checking result will occur after 3s; push any other key to quit.

Output

Click  to call up the menu panel. Click the Utility softkey on panel, select Function in the bottom menu, select Output in the left menu.

Output menu item in the bottom menu sets the output type of Trig Out (P/F) connector on **Fehler! Verweisquelle konnte nicht gefunden werden.** In the bottom menu, select Output.

The description of **Output menu** is shown as the follows:

Menu	Settings	Description
Output	Trig Out	Output trig signal synchronously
	Pass/Fail	Output High Level when Pass, and Low Level when Fail

Device and Print Set menu items set the print output, refer to "**Fehler! Verweisquelle konnte nicht gefunden werden.**"

LAN Set

To use the LAN network connection with the computer, please read the corresponding article "Connection with the PC".

Update

Use the side panel USB port to update your instrument firmware using a USB memory device. Refer to "**Fehler! Verweisquelle konnte nicht gefunden werden.**"

8.1 Set the Display system

Click  to call up the menu panel. Click the **Display** softkey on panel, the Display menu is shown as follows:

Menu	Settings	Description
Type	Dots Vect	Only the sampling points are displayed. The space between the adjacent sampling points in the display is filled with the vector form.
Persist & Color	Time	OFF 1 sec. 2 sec. 5 sec. Infinity Set the persistence time
	Color	ON OFF Turn on/off the color temperature function
Counter	ON OFF	Turn on/off counter
Clear		Erase the results of previous acquisitions from the display. The oscilloscope will start to accumulate acquisitions again.

Display

Press the Display menu selection button. In the lower selection menu, select Type and now you can switch between Dot and Vect by pressing a button.

8.1.1 Persist

When the **Persist** function is used, the persistence display effect of the picture tube oscilloscope can be simulated. The reserved original data is displayed in fade color and the new data is in bright color.

- (1) Click  to call up the menu panel. Click the **Display** softkey on panel.
- (2) Select **Persist&Color** in the bottom menu.
- (3) Select **Persist** in the right menu.
- (4) In the Time menu, select the persist time, including **OFF**, **1 Second**, **2 Seconds**, **5 Seconds** and **Infinity**. When the "**Infinity**" option is set for Persist Time, the measuring points will be stored till the controlling value is changed. Select **OFF** to turn off persistence and clear the display.
- (5) Select **Clear** in the bottom menu to erase the results of previous acquisitions from the display. The oscilloscope will start to accumulate acquisitions again.

8.1.2 Color

Color temperature function uses color-grading to indicate frequency of occurrence. The hot colors like red/yellow indicate frequently occurring events, and the colder colors like blue/green indicate rarely occurring events.

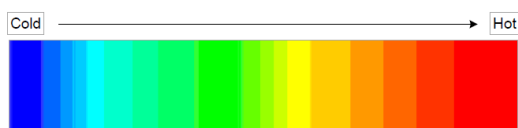

- (1) Click to call up the menu panel. Click the Display softkey on panel.
- (2) Select **Persist&Color** in the bottom menu.
- (3) Select **Color** in the right menu, choose between **ON/OFF**.

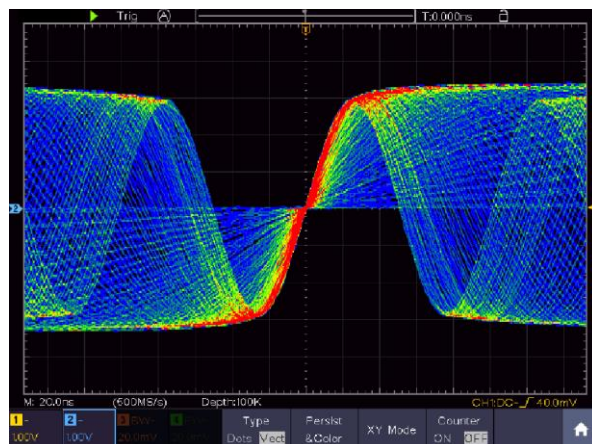

Figure 4.3 Temperature color function is turned on

8.1.3 Counter

It is a 6-digit single-channel counter. The counter can only measure the frequency of the triggering channel. The frequency range is from 2Hz to the full bandwidth. Only if the measured channel is in **Edge** mode of **Single** trigger type, the counter can be enabled. The counter is displayed at the right bottom of the screen.

2 CH:

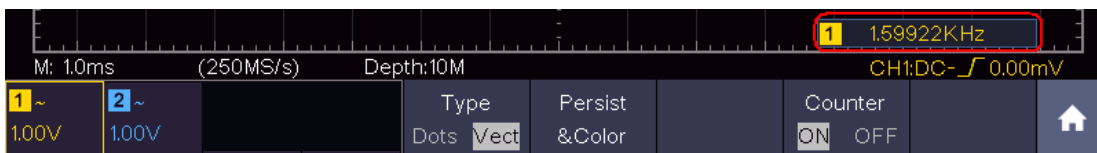

Figure 4.4 Frequency counter display 2CH

4CH:

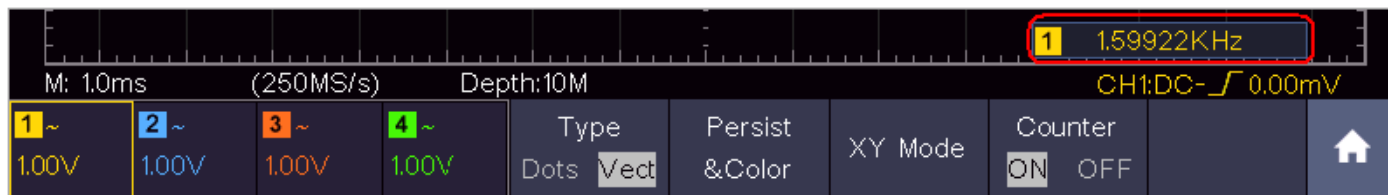



Figure 4.5 Frequency counter display 4CH

Operation steps:

1. Click , click the **Trig Menu** softkey on panel, set the trigger type to **Single**, set the trigger mode to **Edge**, select the signal source.
2. Click , click the **Display** softkey on panel.
3. Select **Counter** as **ON** or **OFF** in the bottom menu.

8.2 Save and recall a waveform

Click  to call up the menu panel. Click the **Save** softkey on panel, you can save the waveforms, configures, screen images, record or clone the waveform.

Function Menu		Settings	Description
Type		Wave Configure Image Record Clone	Choose the saving type. About the Record type, see " Fehler! Verweisquelle konnte nicht gefunden werden. " on PFehler! Textmarke nicht definiert.. About the Clone type, see " Fehler! Verweisquelle konnte nicht gefunden werden. " on PFehler! Textmarke nicht definiert..
When the type is Wave , the menu shows as following:			
Type Wave		Format (Right menu)	For internal storage, only BIN can be selected. For external storage, the format can be BIN, TXT or CSV.
Source		CH1 CH2 CH3 CH4 Math (or MathFFT)	Check the waveform to be saved. (If certain channel is off, the corresponding menu item will be disabled.)
Object & Show	Object	Wave0 to Wave99	Choose the address which the waveform is saved to or recall from.
	Show	ON OFF	Recall or close the waveform stored in the current object address. When the show is ON, if the current object address has been used, the stored waveform will be shown, the address number and relevant information will be displayed at the top left of the screen; if the address is empty, it will prompt "None is saved".
	Close All		Close all the waveforms stored in the object address.

Save		Save the waveform of the source to the selected address. Whatever the Type of save menu is set, you can save the waveform by just pressing the Copy panel button in any user interface. Select Type in the bottom menu, in the right Format menu, you can select the storage format.
Storage	Internal External	Save to internal storage or USB storage. When External is selected, save the waveform according to the current record length (see " Fehler! Verweisquelle konnte nicht gefunden werden. " on P Fehler! Textmarke nicht definiert.); the file name is editable. The BIN waveform file could be open by OWON waveform analysis software (on the supplied CD).
When the type is Configure , the menu shows as following:		
Configure	Setting0 Setting19	The setting address
Save		Save the current oscilloscope configure to the internal storage
Load		Recall the configure from the selected address
When the type is Image , the menu shows as following:		
Save		Save the current display screen. The file can be only stored in a USB storage, so a USB storage must be connected first. The file name is editable. The file is stored in BMP format.

8.2.1 Save and recall the waveform

The oscilloscope can store 100 waveforms, which can be displayed with the current waveform at the same time. The stored waveform called out cannot be adjusted.

In order to save the waveform of CH1, CH2 and Math into the address 1, the operation steps should be followed:

1. Turn on CH1, CH2 and Math channels.
2. Click  to call up the menu panel. Click the **Save** softkey on panel.
3. **Saving**: Select **Type** in the bottom menu, select **Wave** in the left menu.
4. Select **Storage** in the bottom menu, select **Internal** in the right menu.
5. Select **Source** in the bottom menu, check **CH1**, **CH2**, **Math** in the right menu for Source.



6. Select **Object & Show** in the bottom menu, select **Wave1** as object address in the left menu.
7. Select **Save** in the bottom menu to save the waveform.
8. **Recalling:** Select **Object & Show** in the bottom menu, select **Wave1** in the left menu. In the right menu, select **Show** as **ON**, the waveform stored in the address will be shown, the address number and relevant information will be displayed at the top left of the screen.

Tip:

Regardless of which type has been selected in the Save menu, you can always save the current waveform directly as a BIN file using the Copy button, without going through the save menu. If the storage has been set to external, make sure that there is also an external storage medium on the oscilloscope. Please set up the USB storage device as shown in the following chapters.

8.2.2 Save the current screen image

A screenshot can only be saved on an external USB storage device.

1. Install a USB storage device: Insert a USB stick into the "USB host port" of the device. If a USB symbol  is displayed in the upper right, the USB storage device has been correctly recognized and connected. If the USB storage device is not recognized correctly, please proceed as described in the corresponding chapter.
2. After the USB storage device is installed, click  to call up the menu panel. Click the **Save** softkey on panel, the save menu is displayed at the bottom of the screen.
3. Select **Type** in the bottom menu, select **Image** in the left menu.
4. Select **Save** in the bottom menu, an input keyboard used to edit the file name will pop up. The default name is current system date and time. Select the  key in the keyboard to confirm.

8.2.3 Requirements of the USB storage device

The supported file format of a USB storage device is: FAT32 file system with a cluster size of not more than 4KB. A USB mass storage device is also supported. If a connected USB storage device does not work, format it as described in the following two options: Using the system tool or a formatting tool (8Gbyte or larger USB memory sticks can be formatted using the second method).

8.2.4 Use system provided function to format the USB device

1. Connect the USB storage device to the computer
2. Right click **Computer**-> **Manage** to enter Computer Management interface
3. Click Disk Management menu, and information about the USB disk will display on the right side with red mark 1 and 2.

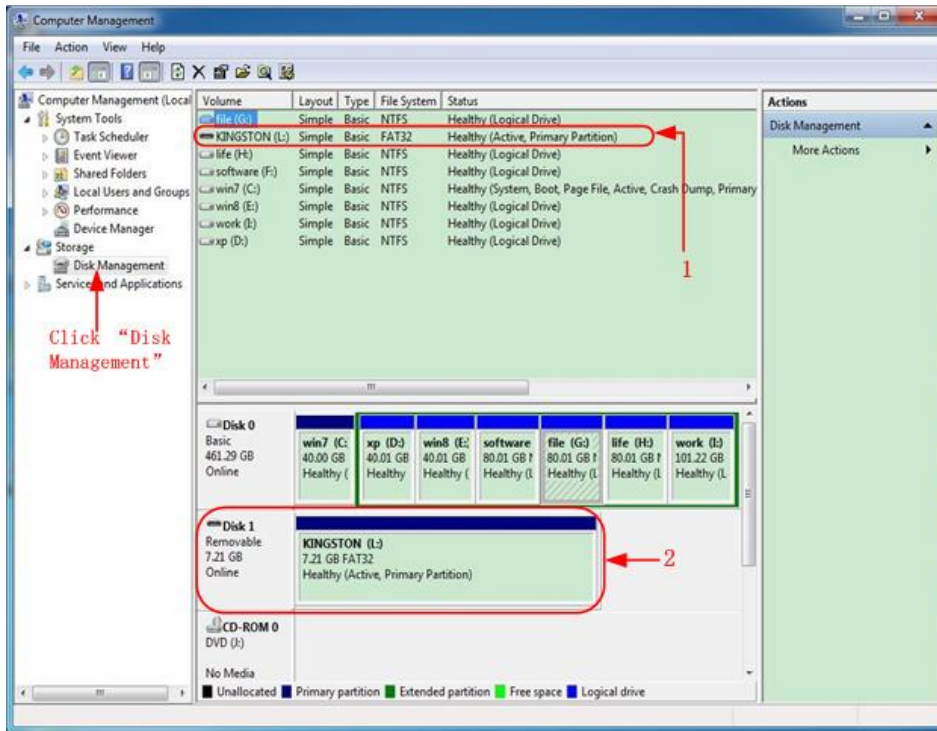

Figure 4.6 Disc manager

1. Right click on the area marked in red and select Format and a warning message appears, which you confirm with YES.

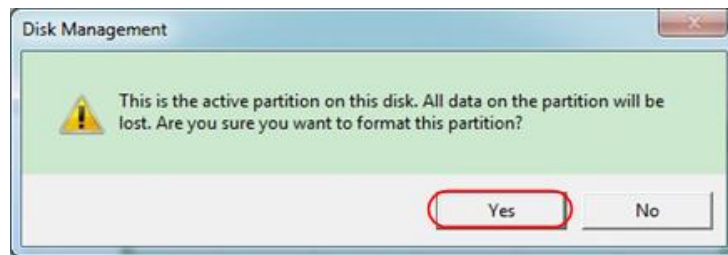

Figure 4.7 Warning message USB

2. Set the file format as FAT32 with a cluster size of 4096. Select quick formatting "Perform a quick format" and confirm with OK and confirm with YES.

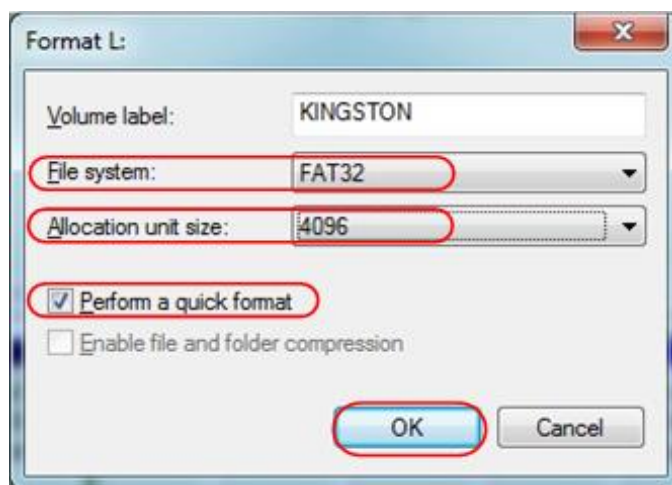

Figure 4.8 Setting for formatting the USB device

3. Formatting process

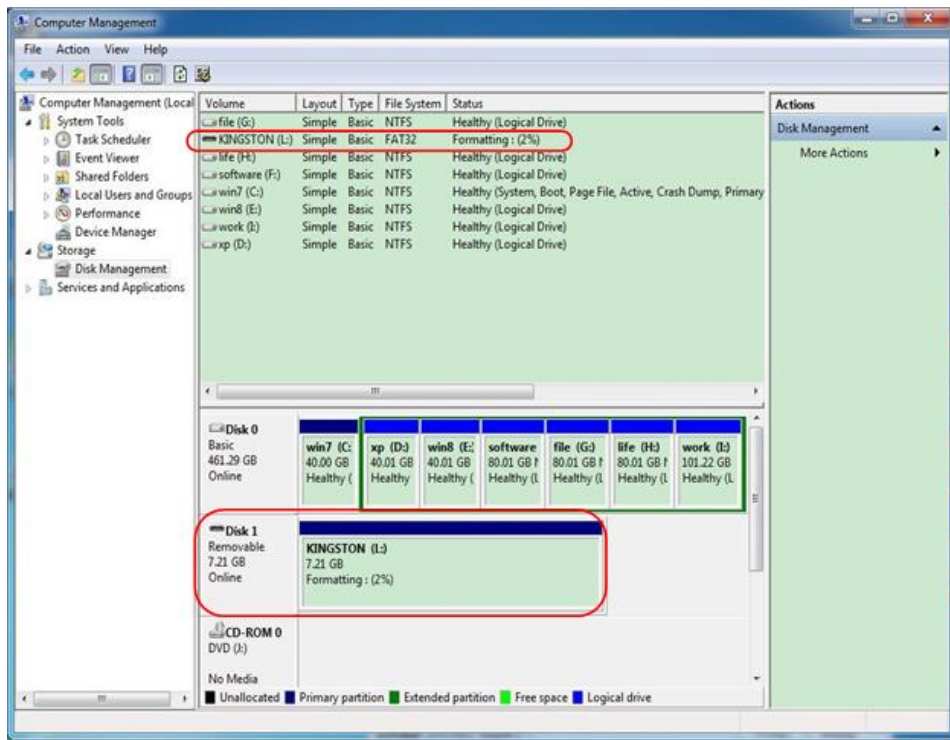

Figure 4.9 Formatting the USB device

4. Check whether the formatting has been carried out and FAT32 with a cluster size of 4096 is now displayed.

8.2.5 Record and playback waveforms

Click to call up the menu panel. Click the **Save** softkey on panel. Select **Type** in the bottom menu, select **Record** in the left menu.

Wave Record function can record the input current wave. You can set the interval between recorded frames in the range of 10 ms - 10 s. The max frame number reaches 1000, and you can get better analysis effect with playback and storage function. The storage medium contains two kinds: Internal and External.

When the storage medium is Internal, Wave Record contains four modes: **OFF**, **Record**, **Playback** and **Storage**.

When storage medium is External, Wave Record contains two modes: **OFF**, **Record**.

Record: To record wave according to the interval until it reaches the end frame set.

Record menu (Internal Storage) shows as follows:

Menu	Settings	Description
Mode	OFF Record Playback Storage	Close wave record function Set record menu Set playback menu Set storage menu
Record Mode Frame Set	End Frame	Click + or - to select the number of frames to record (1 - 1000)
	Interval	Click + or - to select the interval between recorded frames (10ms - 10s)
Refresh	ON OFF	Refresh wave during recording Stop refreshing
Operate	Play Stop	Begin to record Stop recording

Note:

Both of the waveforms of Channel 1 and Channel 2 will be recorded. If a Channel is turned off while recording, the waveform of the channel is invalid in the playback mode.

Playback: Play back the wave recorded or saved.

Playback menu shows as follows:

Menu	Settings	Description
Playback Mode Frame Set	Start Frame	Click + or - to select the number of start frame to playback (1 - 1000)
	End Frame	Click + or - to select the number of end frame to playback (1 - 1000)
	Cur Frame	Click + or - to select the number of current frame to playback (1 - 1000)
	Interval	Click + or - to select the interval between played back frames (10ms - 10s)
Play Mode	Loop	Play back the wave continuously
	Once	Play back the wave just one time
Operate	Play	Begin to record
	Stop	Stop recording

Storage: Save the current wave according to the start frame and end frame set.

Storage menu shows as follows:

Menu	Settings	Description
Storage Mode Frame Set	Start Frame	Click + or - to select the number of start frame to store (1 - 1000)
	End Frame	Click + or - to select the number of end frame to store (1 - 1000)
Save		Save the waveform record file to the internal memory
Load		Load the waveform record file from the memory

Use the waveform record as follows:

1. After opening the menu, press the Save button
2. Select Type in the lower image menu, select Record
3. Select **Mode** in the bottom menu, select **OFF** in the right menu
4. In the bottom menu, select **Storage** as **Internal**
5. Select **Mode** in the bottom menu, select **Record** in the right menu
6. Select **FrameSet** in the bottom menu, set **End frame** and **Interval** in the right menu
7. In the bottom menu, set **Refresh**
8. In the bottom menu, select **Operate** as **Play**
9. Select **Mode** in the bottom menu, select **Playback** in the right menu. Set **FrameSet** and **Playmode**, select **Operate** as **Play**
10. To save the wave recorded, select **Mode** in the bottom menu, select **Storage** in the right menu. Select **FrameSet** in the bottom menu to set the range of frames to store, select **Save** in the bottom menu
11. To load the waveform from the internal memory, select **Load** in the bottom menu, then enter the **Playback** of the **Mode** to analyze the wave

Note: When playback the waveform, the sampling, trigger, or display function is not available.

When storage medium is External, Wave Record contains two modes: OFF, Record

Record menu (External Storage) shows as follows:

Menu	Settings	Instruction
Mode	OFF Record	Close wave record function Set record menu
Record mode FrameSet	End frame	Click + or - to select the number of frames to record (1 – 900,000)
	Interval	Click + or - to select the interval between recorded frames (10ms - 10s)
	Infinity	Record infinitely until the storage medium is full
Refresh	ON	Refresh wave during recording
	OFF	Stop refreshing
Operate	Play	Begin to record
	Stop	Stop recording

Note:

Both of the waveforms of Channel 1 and Channel 2 will be recorded. If a Channel is turned off while recording, the waveform of the channel is invalid in the playback mode.

To use wave record to external, do as follows:

1. Click  to call up the menu panel. Click the **Save** softkey on panel
2. Select **Type** in the bottom menu, in the left menu, select **Record**
3. Select **Mode** in the bottom menu, select **OFF** in the right menu
4. In the bottom menu, select **Storage** as **External**
5. Select **Mode** in the bottom menu, select **Record** in the right menu
6. Select **FrameSet** in the bottom menu, set **End frame** and **Interval** in the right menu. If you want to record wave to external infinitely, select **Infinity** in the right menu, the End frame will display “_”
7. In the bottom menu, set **Refresh**
8. In the bottom menu, select **Operate** as **Play**

Connect external device to the computer, and wave_record_0.bin is the recorded file. Open the software, and do as follows to play back the waveform.

1. Choose Communications → Auto Player
2. Transform recording waveform from machine
3. Add the well transformed files
4. Set play mode and time delay
5. Click the green button on the left corner to begin playing back the waveform.



Bild 4.10 Wiedergabe der Wellenform mittels der Software



8.2.6 Clone and recall a waveform

Click  to call up the menu panel. Click the **Save** softkey on panel. Select **Type** in the bottom menu, select **Clone** in the left menu.

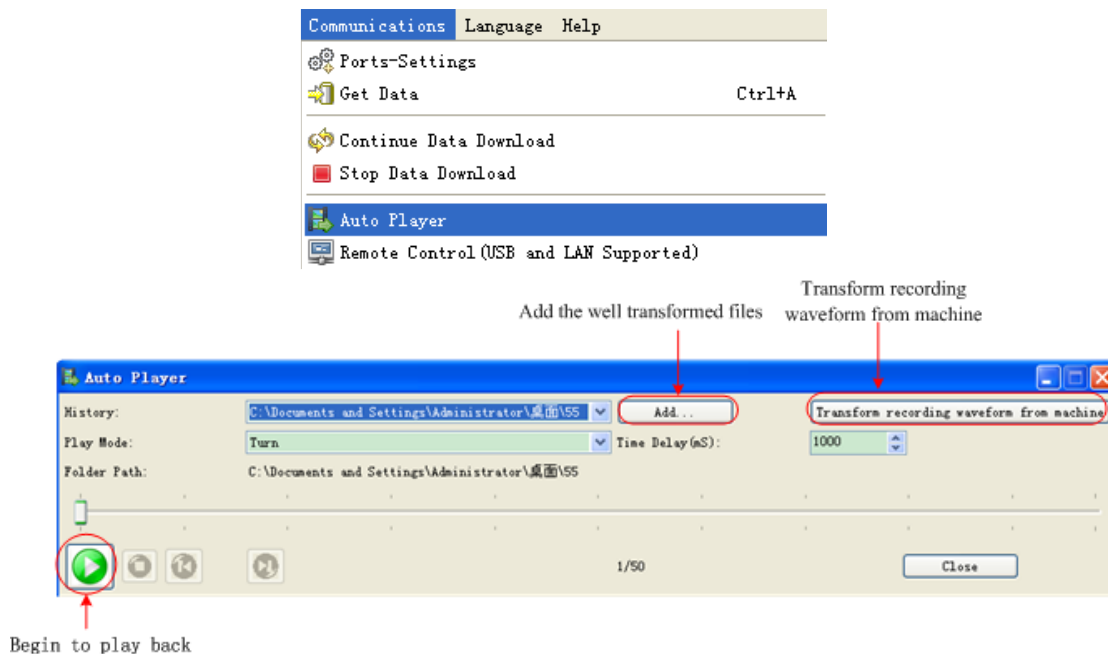

You can clone one or two channel waveforms between two cursors, and save it as a cloned waveform into a USB memory device. The cloned waveform files saved to a USB memory device are saved with the extension "ota".

Clone wave menu:

Menu	Settings	Instruction
Type	Clone	Select the clone function.
Source	Mode	Select the source mode.
	Out1	The cloned waveform includes one waveform, which will be used for AG Out1
	Out2	The cloned waveform includes one waveform, which will be used for AG Out2
	Out1&Out2	The cloned waveform includes two waveforms, which will be used for AG Out1 and AG Out2
	AG Output Out1 CH1 CH2 CH3 CH4	Select the source, which will be used for AG Out1
	AG Output Out2 CH1 CH2 CH3 CH4	Select the source, which will be used for AG Out2

Line	<p>a b ab x</p>	<p>Click line a to select it, swipe left/right to move it. Click line b to select it, swipe left/right to move it. Two cursors are linked. Click line a or b to select them, swipe left/right to move the pair of cursors. Set the cursors to select the entire screen automatically. The waveform information is displayed at the left bottom corner of the screen.</p>  <p>Note: If "Out Of Limits" appears in the information or a message "Waveform points beyond the limit." appears on the screen, that means the length of the cloned waveform exceeds the limit. When the source mode is Out1 or Out2, the maximum length is 2M; When the source mode is Out1&Out2, the maximum length is 1M. Click  to call up the menu panel. Click the Acquire softkey on panel, select Length in the bottom menu, and set the record length to a smaller value.</p>
Save	<p>Save the waveform between two cursors onto a USB memory device. Insert a USB memory device into the port on the side panel. If the icon  appears on the top right of the screen, the USB memory device is installed successfully. If the USB memory device cannot be recognized, format the USB memory device according to the methods in "Fehler! Verweisquelle konnte nicht gefunden werden." on PFehler! Textmarke nicht definiert. The name is default as current system date and time. The cloned waveform will be saved onto the USB memory device as an OTA file.</p>	

To save the CH1 waveform and save to the USB memory:

- (1) Click  to call up the menu panel. Click the **Save** softkey on panel.
- (2) Select **Type** in the bottom menu, select **Clone** in the left menu.
- (3) Select **Source** in the bottom menu, select **Mode** as **Out1** in the right menu.
- (4) Select **AG Output Out1** as **CH1** in the right menu.
- (5) Select **Line** in the bottom menu. If **a** or **b** is selected, swipe to move the cursor. If **ab** is selected, swipe to move the pair of cursors. If **x** is selected, the entire screen will be selected automatically.
- (6) Select **Save** in the bottom menu. An input keyboard used to edit the file name will pop up. Select the keys to input the file name, select the  key in the keyboard to confirm. The cloned waveform will be saved onto the USB memory device as an OTA file.

8.2.7 Data format description of OTA waveform file

If the source mode is set to Out1 or Out2, OTA file consists of two parts: the file header and the channel data. If the source mode is set to Out1&Out2, OTA file consists of three parts: file header, the first channel data, and the second channel data. The file header represents the parameter of file data, which is expressed in "parameter name + value". Each parameter name is a case-sensitive string of 4 bytes. The parameter value is at least 4 bytes.

1. Format description of the file header:

1) HEAD

Parameter name	Meaning	Value	Comment
HEAD	Header size	4 bytes int	

2) TYPE

Parameter name	Meaning	Value	Comment
Type	Model	12 bytes char	

3) BYTE

Parameter name	Meaning	Value	Comment
Byte	Data length in bit	4 bytes int	

4) SIZE

Parameter name	Meaning	Value	Comment
Size	File size	4 bytes int	Used to check the file integrity

5) VOLT

Parameter name	Meaning	Value	Comment
Volt	Voltage division, divided by 400 is ADC resolution (When the source mode is Out 1 & Out 2, it is the first Channel voltage division)	4 bytes float	The value indicates the voltage (the unit is mV), such as 200 mV

6) SAMP

Parameter name	Meaning	Value	Comment
Samp	Sample Rate	4 bytes float	The unit is Sa/s

7) ADCB

Parameter name	Meaning	Value	Comment
ADCB	ADC bit, ADC resolution	4 bytes int	8-bit or 12-bit

8) CHAN

Parameter name	Meaning	Value	Comment
Chan	Number of Channels	4 bytes int	1 or 2

9) VOL2

Parameter name	Meaning	Value	Comment
VOL2	Voltage division, divided by 400 is ADC resolution (When the source mode is Out 1 & Out 2, it is the second channel voltage division)	4 bytes float	The value indicates the voltage (the unit is mV), such as 200 mV

2.Data

The data type is signed integer. You can determine the data type (char, short int or int) based on the BYTE parameter. The valid range is determined by the ADCB parameter, e.g. the valid range for 8-bit ADC is -127 to +127.

9. Measurement functions

9.1 Measure automatically

Click  to call up the menu panel. Click the **Measure** softkey on panel to display the Measure menu. At most 8 types of measurements could be displayed on the bottom left of the screen.

The oscilloscopes provide 39 parameters for auto measurement, including Period, Frequency, Mean, PK-PK, RMS, Max, Min, Top, Base, Amplitude, Overshoot, Preshoot, Rise Time, Fall Time, +PulseWidth, -PulseWidth, +Duty Cycle, -Duty Cycle, Screen Duty, FRR, FRF, FFR, FFF, LRR, LRF, LFR, LFF, Delay A→B⁺, Delay A→B[±], Cycle RMS, Cursor RMS, FRR, FRF, FFR, FFF, LRR, LRF, LFR, LFF, Phase A→B⁺, Phase A→B[±], +PulseCount, -PulseCount, RiseEdgeCnt, FallEdgeCnt, Area, and Cycle Area.

The "Automatic Measurements" menu is described in the following table:

Function Menu		Description
Add	Meas Type (left menu)	Select the measure types
	Source CH1 CH2 CH3 CH4	Select the source
	Add	Add the selected measure types (shown at the left bottom, you could only add 8 types at most)
Remove	Meas Type	Select the types need to be deleted.

	(left menu)	The selected type and source are shown in the Remove menu on the right.
	Remove	Remove the selected measure type
	Remove All	Remove all the measures
Snapshot	ON	Show all the measures of the snapshot source
	OFF	Turn off the snapshot
Source	CH1 CH2 CH3 CH4	Select the snapshot source

9.1.1 Measure

Only if the waveform channel is in the ON state, the measurement can be performed. The automatic measurement cannot be performed in the following situation:

- 1) On the saved waveform
- 2) On Waveform Math waveform
- 3) On the video trigger mode

On the Scan format, period or frequency cannot be measured.

To measure the period or the frequency of CH 1, follow the steps below:

1. Click  to call up the menu panel. Click the **Measure** softkey on panel to show the automatic measurement function menu
2. Select **Add** in the bottom menu
3. In the left Type menu, select **Period**
4. In the right menu, select **Source** as **CH1**
5. In the right menu, select **Add**. The period type is added
6. In the left Type menu, select **Frequency**
7. In the right menu, select **Source** as **CH1**
8. In the right menu, select **Add**. The frequency type is added

The measured value will be displayed at the bottom left of the screen automatically (see fig. 4.11)

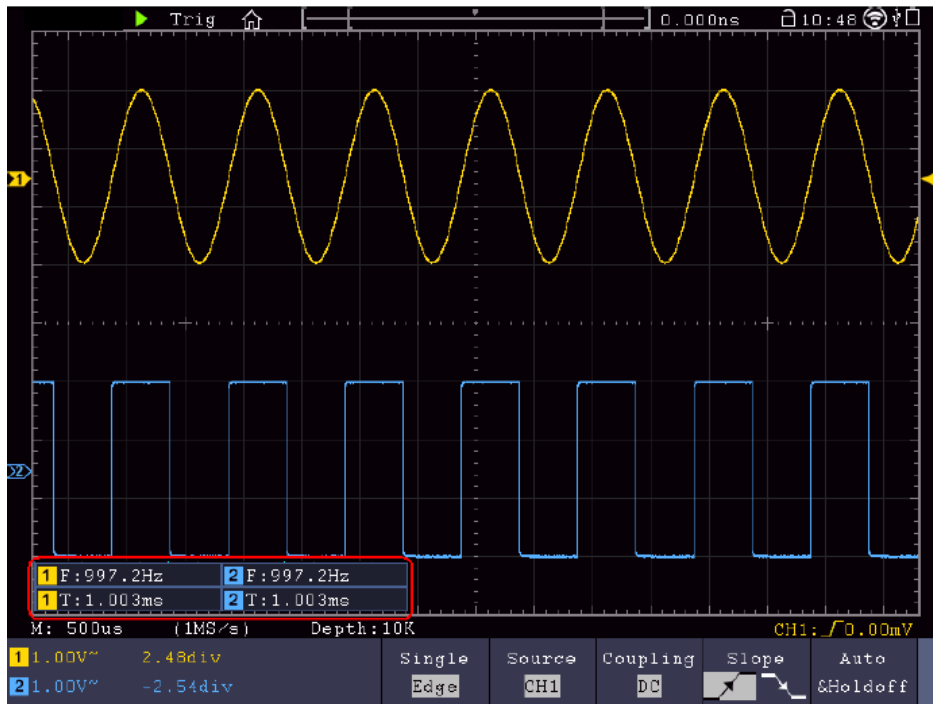

Fig. 4.11 Automatic measurement

9.1.2 Automatic measurement of the voltage parameters

The oscilloscopes provide automatic voltage measurements including Mean, PK-PK, RMS, Max, Min, Vtop, Vbase, Vamp, OverShoot, PreShoot, Cycle RMS, and Cursor RMS. Figure 4.12 shows a pulse with some of the voltage measurement points.

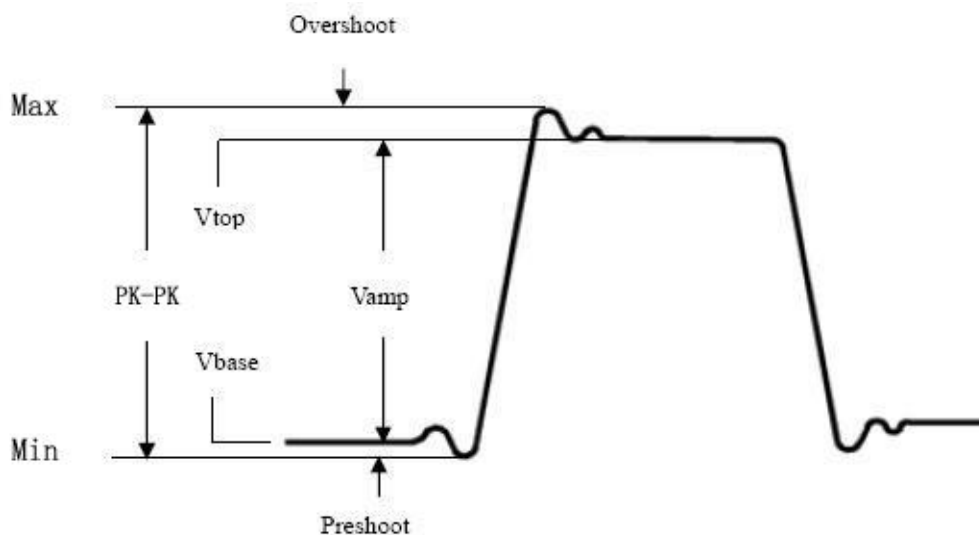

Fig. 4.12 Explanation of the parameters

Mean: The arithmetic mean over the entire waveform

PK-PK: Peak to peak voltage

RMS: The true Root Mean Square voltage over the entire waveform.

Max: The maximum amplitude. The most positive peak voltage measured over the entire waveform.

Min: The minimum amplitude. The most negative peak voltage measured over the entire waveform.

Vtop: Voltage of the waveform's flat top, useful for square/pulse waveforms.
Vbase: Voltage of the waveform's flat base, useful for square/pulse waveforms.
Vamp: Voltage between Vtop and Vbase of a waveform.
Overshoot: Defined as $(V_{max}-V_{top})/V_{amp}$, useful for square and pulse waveforms.
Preshoot: Defined as $(V_{min}-V_{base})/V_{amp}$, useful for square and pulse waveforms.
Cycle RMS: The true Root Mean Square voltage over the first entire period of the waveform.
Cursor RMS: The true Root Mean Square voltage over the range of two cursors.

9.1.3 Automatic measurements of the time parameters

The oscilloscopes provide time parameters auto-measurements include Period, Frequency, Rise Time, Fall Time, +D width, -D width, +Duty, -Duty, Delay A→B ⌘, Delay A→B ⌚, Screen Duty, Phase A→B ⌘, and Phase A→B ⌚, FRR, FRF, FFR, FFF, LRR, LRF, LFR, LFF.

Figure 4.13 shows a pulse with some of the time measurement points:

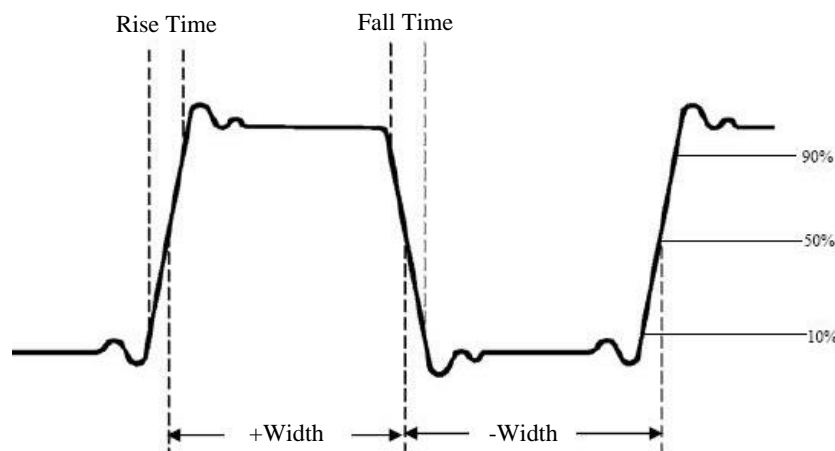

Fig. 4.13 Explanation of the parameters

Rise Time: Time that the leading edge of the first pulse in the waveform takes to rise from 10% to 90% of its amplitude.

Fall Time: Time that the falling edge of the first pulse in the waveform takes to fall from 90% to 10% of its amplitude.

+D width: The width of the first positive pulse in 50% amplitude points.

-D width: The width of the first negative pulse in the 50% amplitude points.

+Duty: +Duty Cycle, defined as $+Width/Period$.

-Duty: -Duty Cycle, defined as $-Width/Period$.

Delay A→B ⌘: The delay between the two channels at the rising edge.

Delay A→B ⌚: The delay between the two channels at the falling edge.

Screen Duty: Defines as $(\text{the width of the positive pulse})/(\text{Entire period})$

Phase A→B ⌘: Phase difference calculated according to " Delay A→B ⌘ " and the period of source A, expressed in degree. The calculation formula is as shown below:

$$\text{Phase A} \rightarrow \text{B} \lrcorner = (\text{Delay A} \rightarrow \text{B} \lrcorner \div \text{Period of source A}) \times 360^\circ$$

Phase A→B ⌚: Phase difference calculated according to " Delay A→B ⌚ " and the period of source A, expressed in degree. The calculation formula is as shown below:

$$\text{Phase A} \rightarrow \text{B} \lrcorner = (\text{Delay A} \rightarrow \text{B} \lrcorner \div \text{Period of source A}) \times 360^\circ$$

Note for the following delay measurements:

Source A and Source B can be set in the automatic measurement function menu.

FRR: Time between Source A first rising edge and Source B first rising edge.

FRF: Time between Source A first rising edge and Source B first falling edge.

FFR: Time between Source A first falling edge and Source B first rising edge.

FFF: Time between Source A first falling edge and Source B first falling edge.

LRR: Time between Source A first rising edge and Source B last rising edge.

LRF: Time between Source A first rising edge and Source B last falling edge.

LFR: Time between Source A first falling edge and Source B last rising edge.

LFF: Time between Source A first falling edge and Source B last falling edge.

9.1.4 Other measurement functions

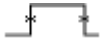
+PulseCount : The number of positive pulses that rise above the mid reference crossing in the waveform.

-PulseCount : The number of negative pulses that fall below the mid reference crossing in the waveform.

RiseEdgeCnt : The number of positive transitions from the low reference value to the high reference value in the waveform.

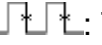
FallEdgeCnt : The number of negative transitions from the high reference value to the low reference value in the waveform.

Area : The area of the whole waveform within the screen and the unit is voltage-second. The area measured above the zero reference (namely the vertical offset) is positive; the area measured below the zero reference is negative. The area measured is the algebraic sum of the area of the whole waveform within the screen.

Cycle Area :  The area of the first period of waveform on the screen and the unit is voltage-second. The area above the zero reference (namely the vertical offset) is positive and the area below the zero reference is negative. The area measured is the algebraic sum of the area of the whole period waveform.

Note: When the waveform on the screen is less than a period, the period area measured is 0.

9.1.5 Adjustment of the automatic measurement

This chapter explains how it is possible to adapt the automatic measurement. Adjust an automatic measurement using the gating and statistics functions as follows:

Gating

- Press the measuring system under the TrigMenu tab. The menu for the automatic measurement function is displayed at the bottom of the screen.
- Press the Set button at the bottom of the screen. The settings menu is displayed on the right side of the screen.

- Select the gating menu. There are two menus: Screen and Cursor under the area. Click Screen, then click the cursor or press the right on-screen menu key twice to set the cursor area.

Statistics

Choose Statistics. You can select On or Off to enable or disable statistics on the reading. Reset statistics: Restart the statistics.

9.2 Measure with the Cursors

Click  to call up the menu panel. Click the **Cursor** softkey on panel to switch to the ON state and display the cursor menu. Click it again to turn cursors off.

Cursor measurement for the normal mode:

The description of the **cursor menu** is shown in the following table:

Function Menu	Settings	Description
Type	Voltage Time Time&Voltage AutoCursr	Display the voltage measurement cursor and menu. Display the time measurement cursor and menu. Display the time and voltage measurement cursor and menu. The horizontal cursors are set as the intersections of the vertical cursors and the waveform
Line Type (Time&Voltage type)	Time Voltage	Makes the vertical cursors active. Makes the horizontal cursors active.
Window (Wave zoom mode)	Main Extension	Measure in the main window. Measure in the extension window.
Source	CH1 to CH4	Display the channel to which the cursor measurement will be applied.

Perform the following operation steps for the time and voltage cursor measurement of the channel CH1:

1. Click  to call up the menu panel. Click the **Cursor** softkey on panel to switch to the ON state and display the cursor menu.
2. Select **Source** in the bottom menu, select **CH1** in the right menu.
3. Select the first menu item in the bottom menu, the **Type** menu will display at the right of the screen. In the right menu, select **Time&Voltage** for Type, two blue dotted lines displayed along the horizontal direction of the screen, two blue dotted lines displayed along the vertical direction of the screen. Cursor measure window at the left bottom of the screen shows the cursor readout.
4. In the bottom menu, select **Line Type** as **Time** to make the vertical cursors active. Click line **a** to select it, swipe left/right to move it. Click line **b** to select it, swipe left/right to move it.
5. In the bottom menu, select **Line Type** as **Voltage** to make the horizontal cursors active. Click line **a** to select it, swipe up/down to move it. Click line **b** to select it, swipe up/down to move it.

- Push the **Horizontal HOR** button to enter wave zoom mode. In the bottom cursor menu, select **Window** as **Main** or **Extension** to make the cursors shown in the main window or zoom window.

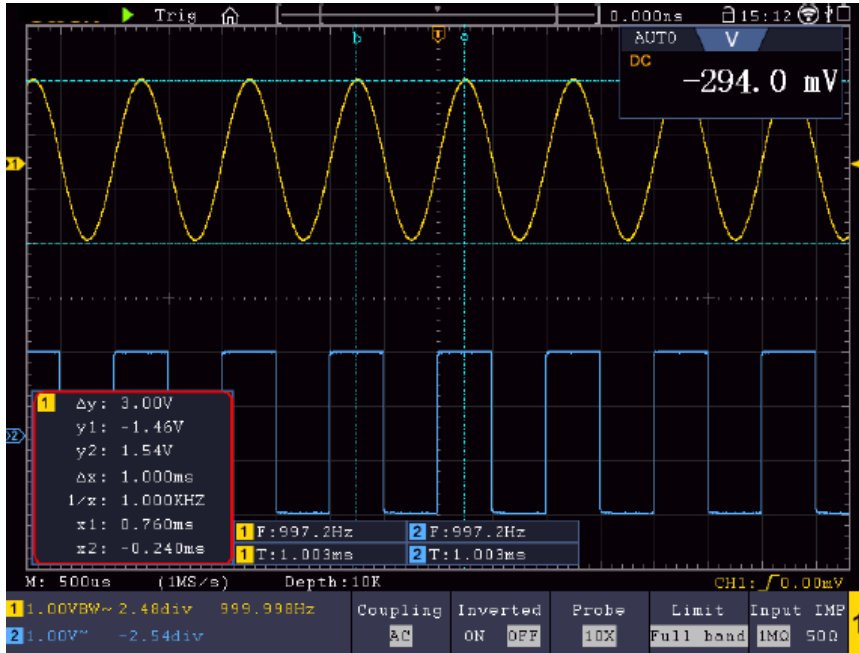

Fig. 4.14 Time & Voltage cursor measurement

Auto Cursor

For the AutoCursor type, the horizontal cursors are set as the intersections of the vertical cursors and the waveform.



Bild 4.15 Auto Cursor



9.2.1 Cursor measurements in FFT mode

In FFT mode, press the cursor button to open the cursor menu.

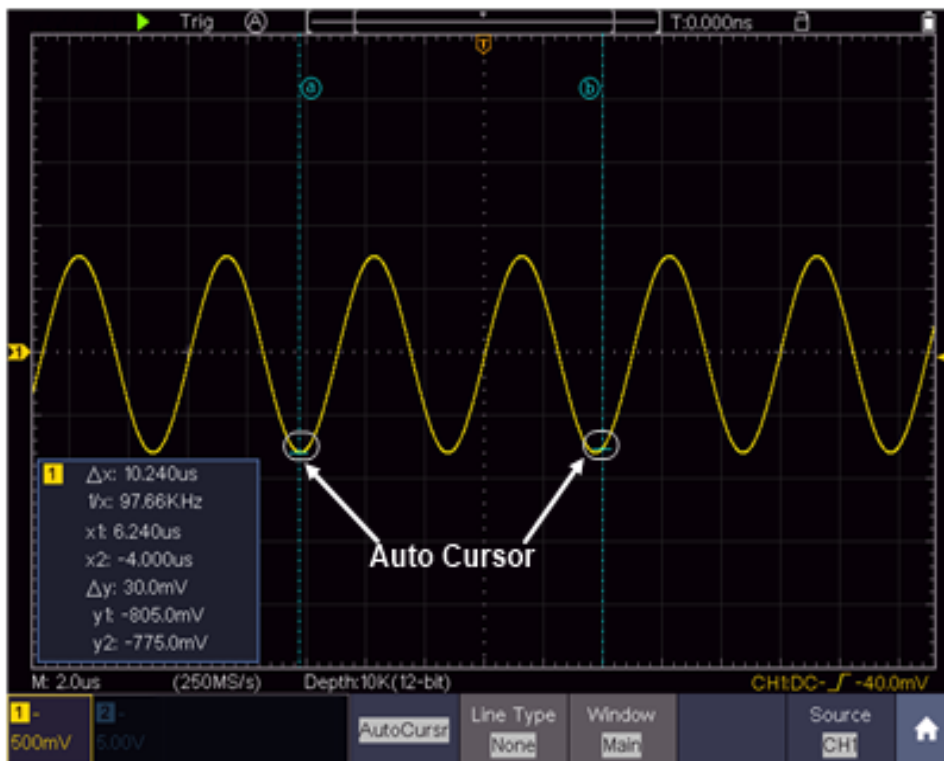
A description of the cursor menu in FFT mode can be found below:

Menu	Settings	Description
Type	Vamp Freq Freq&Vamp Auto Cursor	Display the Vamp (or Phase) measurement cursor and menu Display the Freq measurement cursor and menu Display the corresponding measurement cursor and menu The horizontal cursors are set as the intersections of the vertical cursors and the waveform
Line Type (Freq&Vamp or Freq&Phase type)	Freq Vamp	Makes the vertical cursors active Makes the horizontal cursors active
Window (Wave zoom mode)	Main Extension	Measure in the main window Measure in the FFT extension window
Source	Math FFT	Display the channel to which the cursor measurement will be applied

Perform the following operation steps for the amplitude and frequency cursor measurement of math FFT:

1. Click  to call up the menu panel. Click the **FFT** softkey on panel to switch to the ON state and display the FFT menu. In the bottom menu, select Format. In the right menu, select amplitude unit (**V RMS** or **Decibels**).
2. Click  to call up the menu panel. Click the **Cursor** softkey on panel to switch to the ON state and display the cursor menu.
3. In the bottom menu, select **Window** as **Extension**.
4. Select the first menu item in the bottom menu, the **Type** menu will display at the right of the screen. In the right menu, select **Freq&Vamp** for Type, two blue dotted lines displayed along the horizontal direction of the screen, two blue dotted lines displayed along the vertical direction of the screen. Cursor measure window at the left bottom of the screen shows the cursor readout.
5. In the bottom menu, select **Line Type** as **Freq** to make the vertical cursors active. Click line **a** to select it, swipe left/right to move it. Click line **b** to select it, swipe left/right to move it.
6. In the bottom menu, select **Line Type** as **Vamp** to make the horizontal cursors active. Click line **a** to select it, swipe up/down to move it. Click line **b** to select it, swipe up/down to move it.
7. In the bottom cursor menu, you can select **Window** as **Main** to make the cursors shown in the main window.

9.3 Mathematical manipulation function

The Mathematical Manipulation function is used to show the results of the addition, multiplication, division and subtraction operations between two channels, advanced math feature including Intg, Diff, Sqrt, user defined function, and digital filter. Click  to call up the menu panel. Click the Math softkey on panel to switch to the ON state and display the math menu on the bottom.

The waveform calculation menu:

Menu		Settings	Description
Waveform Math	Factor1	CH1 CH2 CH3 CH4	Select the signal source of the factor1
	Sign	+ - * /	Select the sign of mathematical manipulation
	Factor2	CH1 CH2 CH3 CH4	Select the signal source of the factor2
	Vertical (div)	Click + or - to adjust the vertical position of the Math waveform	
	Vertical (V/div)	Click + or - to adjust the vertical division of the Math waveform	
User function	Edit fun	Intg, Diff, Sqrt, and user defined function	
	Vertical (div)	Click + or - to adjust the vertical position of the Math waveform	
	Vertical (V/div)	Click + or - to adjust the vertical division of the Math waveform	
DIR	Channel	CH1 CH2	Select channel
	Type	low-pass	Only the signals whose frequencies are lower than the current cut-off frequency can pass the filter.
		high-pass	Only the signals whose frequencies are greater than the current cutoff frequency can pass the filter.
		band-pass	Only the signals whose frequencies are greater than the cutoff frequency down and lower than the current cutoff frequency upper can pass the filter.
		band-reject	Only the signals whose frequencies are lower than the current cutoff frequency down or greater than the current cutoff frequency upper can pass the filter.

	Window	Retangular Tapered Triangular Hanning Hamming Blackman	Select window for digital filter
	cut-off fre or upper down	Click + or - to set cut-off frequency	
	Vertikal (div)	Drücken Sie auf + oder - , um die vertikale Position der mathematischen Wellenform anzupassen	

Example waveforms add CH1 & CH2:

1. Click **Home** to call up the menu panel. Click the **Math** softkey on panel to switch to the ON state and display the math menu on the bottom. The pink M waveform appears on the screen
2. Select **Waveform Math** in the bottom menu
3. In the right menu, select **Factor1** as CH1
4. Select **Sign** as **+** in the right menu
5. In the right menu, select **Factor2** as **CH2**
6. Select **Vertical (div)** in the right menu, click **+** or **-** to adjust the vertical position of Math waveform
7. Select **Vertical (V/div)** in the right menu, click **+** or **-** to adjust the vertical division of Math waveform

9.4 User defined function

1. Click the **Math** softkey on panel to switch to the ON state and display the math menu on the bottom
2. Select **User Function** in the bottom menu, select **Edit fun** in the right menu, an expression input keyboard pops up

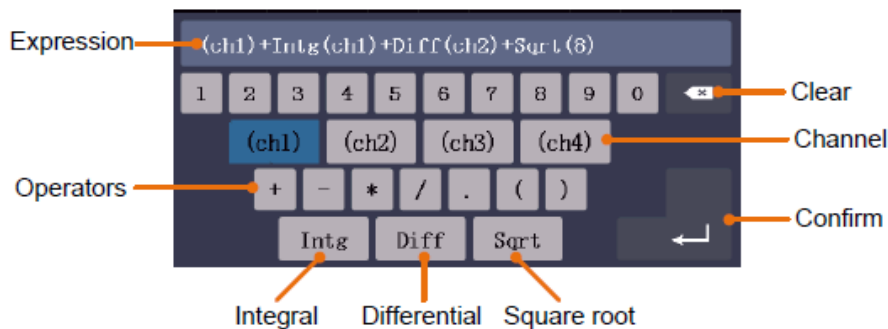

Figure 4.16 Keyboard

3. Create an expression. When done, choose **Confirm** in the keyboard to confirm. The division of Math waveform is displayed at the left bottom of screen

9.5 Digital filter





Digital filter provides 4 types of filters (low pass, high pass, band pass and band reject). The specified frequencies can be filtered by setting the cut-off frequency. Digital filters can only be used for CH1 or CH2.

1. Click the **Math** softkey on panel to switch to the **ON** state and display the math menu on the bottom
2. Select **DIR** in the bottom menu
3. In the right menu, select **channel** as **CH1** or **CH2**
4. In the right menu, select **type**, select the desired filter type
5. In the right menu, select **window**, select the desired window
6. When **low-pass** or **high-pass** type is selected, select **cut-off fre** in the right menu. When **band-pass** or **band-reject** type is selected, select **upper** or **down** in the right menu. Click **+** or **-** to adjust the frequency
7. In the right menu, select **Vertical (div)**, click **+** or **-** to adjust the vertical position of Math waveform. The voltage division of Math waveform is the same as the selected channel



9.6 Autoscale function

This is a function which is used to carry out a simple and quick test on the input signal. The function is applied to follow-up signals automatically even if the signals change at any time. Autoscale enables the instrument to set up trigger mode, voltage division and time scale automatically according to the type, amplitude and frequency of the signals.

Press Autoscale to display the following menu:

Menu	Settings	Description
AutoScale	ON OFF	Switching on the autoscale function Switching off the autoscale function
Mode		Follow-up and adjust both vertical and horizontal settings.
		Follow-up and only adjust horizontal scale.
		Follow-up and only adjust vertical scale.
Waveform		Show multi period waveforms
		Shows only one or two periods

To measure the signal using autoscale, you can do as the follows:

1. Click  to call up the menu panel. Click the **Autoscale** softkey on panel to switch to the ON state. The function menu will appear.
2. In the bottom menu, Select **Mode**. In the right menu, select .
3. In the bottom menu, Select **Wave**. In the right menu, select .

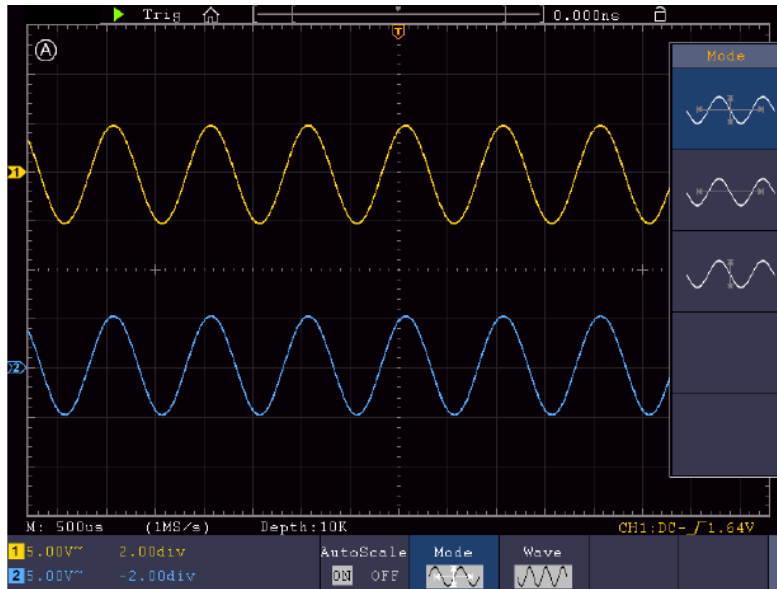

Figure 4.17 Autoscale function

1. When entering into Autoscale function, a autoscale indicator will be flickering on the top left of the screen.
2. In the mode of Autoscale, the oscilloscope can self-estimate Trigger Mode (Edge, Video). At this point, the trigger menu is not available.
3. When the input signal contains the DC component, the coupling will be set to AC, the amplitude of the input signal should be greater than 5mV, and the frequency should be greater than 20Hz.
4. At the mode of Autoscale, DSO is always set as DC coupling with AUTO triggering, the holdoff is set to 100ns.
5. At the mode of Autoscale, if adjust the vertical position, voltage division, trigger level or time scale, the oscilloscope will pause the Autoscale function. To resume Autoscale, push the **Autoset** front panel button.
6. When video triggering, the horizontal time scale is 50us.
7. While the Autoscale is working, the settings below will be made forcibly:

The DSO will switch from the wave zoom mode to the normal mode. In the decoding, pass/fail or XY mode, when entering into Autoscale, these modes will be turned off. In the STOP status, when entering into Autoscale, the status will be set to RUN.

9.7 FFT function

FFT refers to the Fourier transform operation on a certain channel.

The FFT menu:

Source		CH1 CH2 CH3 CH4	Select the FFT source.
Window		Rectangle Hanning Hamming Blackman Bartlett Kaiser	Select window for FFT.
Format		Vrms dB Radian Degrees	V RMS and Decibels are amplitude units; Radian, Degrees are phase units
Display	Hori	Position value Time base value/	Switch to select the horizontal position or time base of the FFT waveform, click + or - to adjust it.
	Vertical	Position value Division value/	Switch to select the vertical position or voltage division of the FFT waveform, click + or - to adjust it.
FFT Peak	ON OFF	Enable or disable FFT peak search. Dynamic marker ∇ marks the FFT peak.	

The FFT (fast Fourier transform) math function mathematically converts a time-domain waveform into its frequency components. It is very useful for analyzing the input signal on Oscilloscope. You can match these frequencies with known system frequencies, such as system clocks, oscillators, or power supplies.







FFT function in this oscilloscope transforms 8192 data points of the time-domain signal into its frequency components mathematically (the record length should be 10K or above). The final frequency contains 4096 points ranging from 0Hz to Nyquist frequency.

Example for the FFT function operation:

1. Click **⏠** to call up the menu panel. Click the **FFT** softkey on panel to switch to the ON state and display the FFT menu on the bottom. The pink M waveform appears on the screen.
2. In the bottom menu, select **Source**. In the right menu, select CH1.
3. In the bottom menu, select **Window**. In the right menu, select the proper window type.
4. In the bottom menu, select **Format**. In the right menu, select amplitude unit (V RMS, Decibels) or phase unit (Radian, Degrees).
5. In the bottom menu, select **Display**. In the right menu, select **Hori (Hz)**; select repeatedly to make the **M** symbol in front of the horizontal position value (the upper one), click **+** or **-** to adjust the horizontal position of FFT waveform; then select to make the **M** symbol in front of the time base value below, click **+** or **-** to adjust the time base of FFT waveform.
6. Select **Vertical** in the right menu; do the same operations as above to set the vertical position and vertical division.

9.7.1 Select the FFT window

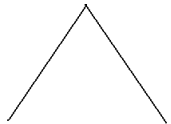
There are 6 FFT windows. Each one has trade-offs between frequency resolution and magnitude accuracy. What you want to measure and your source signal characteristics help you to determine which window to use. Use the following guidelines to select the best window:

Type	Characteristics	Window
Rectangle	<p>Best solution for frequency, worst for magnitude. Best type for measuring the frequency spectrum of nonrepetitive signals and measuring frequency components near DC. Recommend to use for:</p> <ul style="list-style-type: none"> • Transients or bursts, the signal level before and after the event are nearly equal • Equal-amplitude sine waves with frequencies those are very close • Broadband random noise with a relatively slow varying spectrum 	
Hanning	<p>Good for magnitude, but poorer frequency resolution than Hamming. Recommend to use for:</p> <ul style="list-style-type: none"> • Sine, periodic and narrow band random noise • Transients or bursts where the signal levels before and after the event are significantly different 	
Hamming	<p>Better solution for magnitude than Rectangle, and good for frequency as well. It has slightly better frequency resolution than Hanning. Recommend to use for:</p> <ul style="list-style-type: none"> • Sine, periodic and narrow band random noise • Transients or bursts where the signal levels before and after the event are significantly different 	
Blackman	<p>Best solution for magnitude, worst for frequency. Recommend to use for:</p> <ul style="list-style-type: none"> • Single frequency waveforms, to find higher order harmonics 	
Bartlett	<p>The Bartlett window is a slightly narrower variant of the triangular window, with zero weight at both ends.</p>	
Kaiser	<p>The frequency resolution when using the Kaiser window is fair; the spectral leakage and amplitude accuracy are both good. The Kaiser window is best used when frequencies are very close to the same value but have widely differing amplitudes (the side lobe level and shape factor are closest to the traditional Gaussian RBW). This window is also good for random signals.</p>	

Notes for using FFT

- Use the default **dB** scale for details of multiple frequencies, even if they have very different amplitudes. Use the **Vrms** scale to compare frequencies.
- DC component or offset can cause incorrect magnitude values of FFT waveform. To minimize the DC component, choose AC Coupling on the source signal.
- To reduce random noise and aliased components in repetitive or single-shot events, set the oscilloscope acquisition mode to average.

What is Nyquist frequency?

The Nyquist frequency is the highest frequency that any real-time digitizing oscilloscope can acquire without aliasing. This frequency is half of the sample rate. Frequencies above the Nyquist frequency will be under sampled, which causes aliasing. So, pay more attention to the relation between the frequency being sampled and measured.

9.8 XY Mode

XY mode is used to display the amplitude of one waveform versus the amplitude of another. The data point from the first waveform defines the horizontal position, while the corresponding data point from the second waveform shows the vertical position for each point.

The oscilloscope is in the untriggered sampling mode: the data are displayed as bright points.

Operating the buttons:

- When the HOR button is lit, the upper and lower buttons are used to adjust the horizontal scale and position
- If one of the channel buttons is lit, the vertical scaling and position are set with the upper and lower buttons

The following functions are not available in the XY mode:

- Reference or digital waveforms
- Cursor
- Trigger control
- FFT

Operating steps:

1. Click  to call up the menu panel. Click the **XY** softkey on panel to switch to the ON state
2. To make the XY view full screen, select **Full Screen** as **ON** in the bottom menu

9.9 Pass/Fail

The **Pass/Fail** function monitors changes of signals and output pass or fail signals by comparing the input signal that is within the pre-defined mask.

Click  to call up the menu panel. Click the **P/F** softkey on panel to switch to the ON state.

The pass/Fail function:

Menu	Settings	Description
Operate	Start Stop	Start operation Stop operation
Output	Pass Fail Beep Stop Info	Signal tested corresponds with the rule Signal tested not correspond with the rule Beep when it satisfies the rule Stop once satisfying the rule Control the display status of info frame
Rule	Source Horizontal Vertical Create	Select the source as CH1, CH2, CH3 or CH4 Change the Horizontal tolerance value by clicking + or - Change the Vertical tolerance value by clicking + or - Use the rule set as testing rule
Save rule	Number Save Load	Select any one from Rule1 - Rule8 as your rule name Select Save to save the rule Load some rule as the testing rule

Pass/Fail test:

Detect whether the input signal is within the limits of the rule, if it exceeds limits of the rule, it is "Fail"; otherwise it is "Pass". Also, it can output fail or pass signal by built-in and configurable output port.

To run the test, read the following steps:

1. Click  to call up the menu panel. Click the **P/F** softkey on panel to switch to the **ON** state.
2. **Create rule:** Select **Rule** in the bottom menu. Select **Source** in the right menu. Set **Horizontal** tolerance and **Vertical** tolerance in the right menu. Select **Create** in the right menu to create the rule.
3. **Set output type:** Select **Output** in the bottom menu to enter output option setting. Choose any one or two of the options "**Pass**", "**Fail**" or "**Beep**". "**Pass**" and "**Fail**" are mutually exclusive options, which could not be chosen simultaneously. "**Stop**" means stop once the condition satisfies your setting.
4. **Begin to test:** Select **Operate** in the bottom menu, switch it to **Start**, the test will begin.
5. **Save rule:** Select **SaveRule** in the bottom menu. Select the save location in the left menu, and then select **Save** in the right menu to save the rules, which could be called up at once when need. Select **Load** to call up the rule saved.

Note:

1. When Pass/Fail is ON, if XY or FFT is ready to run, then Pass/Fail will be closed; under the mode of XY or FFT, Pass/Fail is unable.
2. Under the mode of Factory, Auto Scale and Auto Set, Pass/Fail will be closed.
3. When no save setting left in the rule save, tip will be given to show "NO RULE SAVED".
4. Under the status of stop, data comparing will stop, and when it goes on running, the number of Pass/Fail will increase from the former number, not from zero.
5. When the waveform playback mode is on, Pass/Fail is used to test the played-back waveform specially.

10. Executive buttons

Executive buttons include Copy, Default, Run/Stop, Single and Autoset

Autoset

This button is used to automatically set all the control values of the device required for the generation of a viewable waveform. Press the AUTOSSET button; the oscilloscope then performs a quick automatic measurement of the signal.

The following table shows the parameter values of the Autoset function:

Functions	Settings
Channel Coupling	DC
Vertical Scale	Adjust to the proper division.
Vertical Position	Adjust to the proper position.
Bandwidth	Full
Horizontal Level	Middle
Horizontal Sale	Adjust to the proper division
Trigger Type	Slope or Video
Trigger Source	The previous source before autosecting. When the previous source has no input signal, the source will be set to the minimum channel which has input signal. When all the channels have no input signal, the source will be set to CH1.
Trigger Coupling	DC
Trigger Slope	Rising edge
Trigger Level	3/5 of the Vpk-pk
Trigger Mode	Auto
Display Format	YT
Force	Stop
Help	Exit
Pass/Fail	Off
Inverted	Off

Zoom Mode	Exit
Record Length	If greater than 10M, it will be set to 10M
Waveform Math or FFT	Off
Waveform Record	Off
Slow-scan	Off
Persist	Off

Note: When the autoscale is turned on and running, the Autoset button is invalid.

Description of the icons:

Cancel Autoset : Go back to display the upper menu and waveform information.

The Autoset function requires that the frequency of signal should be no lower than 20Hz, and the amplitude should be no less than 5mv. Otherwise, the Autoset function may be invalid.

Run/Stop

Enable or disable sampling on input signals.

Notice: When there is no sampling at STOP state, the vertical division and the horizontal time base of the waveform still can be adjusted within a certain range, in other words, the signal can be expanded in the horizontal or vertical direction.

When the horizontal time base is $\leq 50\text{ms}$, the horizontal time base can be expanded for 4 divisions downwards.

Single

Push this button you can set the trigger mode as single directly, so when trigger occurs, acquire one waveform then stop.

Copy

You can save the waveform by just pushing the **Copy** panel button in any user interface. The source wave and the storage location are according to the settings of the **Save** function menu when the Type is **Wave**

10.1 Print the screen image

Follow the steps to print an image of the oscilloscope screen:

1. Connect the printer to the **USB Device** port on the side panel of the oscilloscope.
Note: The USB Device port supports PictBridge compatible printers.
2. Click  to call up the menu panel. Click the **Utility** softkey on panel, select **Function** in the bottom menu, select **Output** in the left menu.
3. In the bottom menu, select **Device** as **PICT**. (When **PC** is selected, you can get an image by Oscilloscope software.)
4. In the bottom menu, select **Print Set**. In the right menu, set the print parameters. The **On** selection of **Ink Saver** will print out a copy with a white background.
5. Once you have connected a printer to your oscilloscope and set up print parameters, click **Play** in the bottom menu to print current screen images.

11. Using the multimeter

The integrated multimeter can be switched on and off using the DMM button. The display window appears in the upper right-hand side of the screen after the function has been activated. The multimeter function is only available for the PeakTech 1206 and PeakTech 1207 oscilloscope models.

11.1 Connections of the multimeter

The input terminals are on the top of the oscilloscope, which marked as **COM**, **V/Ω/C**.

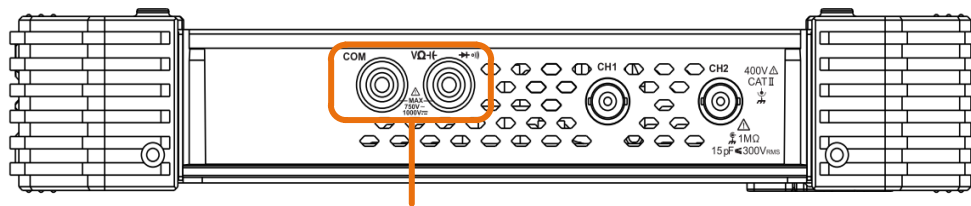

Input connectors of multimeter

Figure 5.1 Multimeter connection sockets

11.2 Menu of the multimeter

Press the DMM button on the front to access the multimeter function. The backlight of the button lights up when the multimeter function is activated.

The measuring function is selected with the Select button. Switch between AC and DC when measuring voltage or current. Furthermore, it is possible to choose between resistance measurement, capacitance measurement, continuity test and diode test using the Select button.

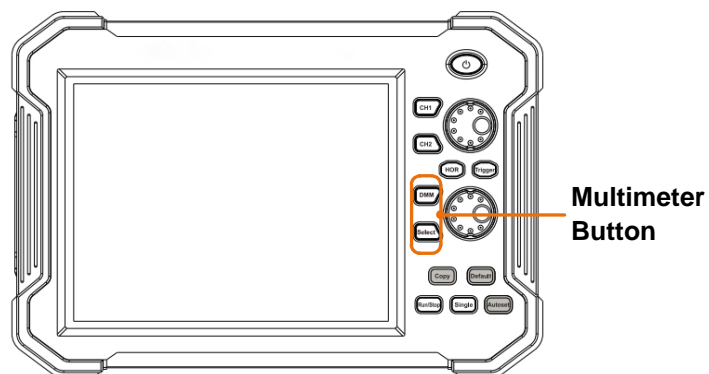



Figure 5.2 Multimeter function buttons

The multimeter menu is described in the following table:

Menu	Settings	Description
Current	ACA	Measuring AC current
	DCA	Measuring DC current
Voltage	ACV	Measuring AC voltage
	DCV	Measuring DC voltage
	R	Resistance measurement
		Diode test
		Testing continuity
	C	Capacitance measurement
Hold	ON	Freeze the display during measurement
	OFF	
Configure	Relative	Setzt den aktuellen Messwert auf null. Die Messung ist der Differenzwert des Referenzwertes zur aktuellen Messanzeige.
	Show info	Show / Hide the information window
	ON OFF	
	Auto range	Select auto range mode
	Manual range selection	Select manual range mode

11.3 DMM information window

The multimeter information window is displayed on the top right of the screen

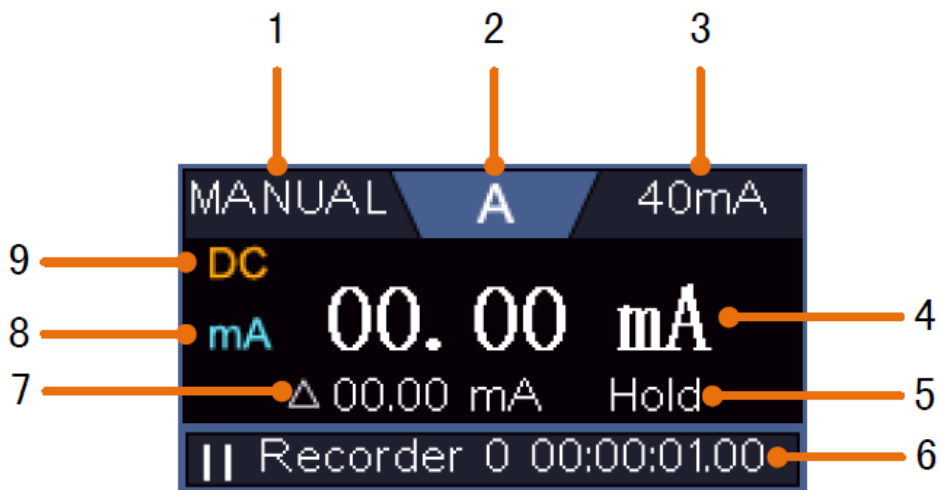



Figure 5.3 Multimeter measurement screen

Description

1. Manual/Auto range indicators, MANUAL refers to the measuring range in manual operation mode and AUTO refers to the measuring range in automatic operation mode.
2. Measurement mode indicators:

V	Voltage measurement
A	Current measurement
R	Resistance measurement
	Diode measurement
C	Capacitance measurement
	Continuity test

3. Current measuring range
4. Measured value with unit
5. Data-Hold activated
6. Multimeter recorder
7. Reference value of the relative measurement
8. Range of measuring current: mA or 10A
9. AC or DC when measuring current or voltage

11.4 Measurements with the multimeter

11.4.1 AC/DC voltage measurement

1. Push **DMM** button on the front panel. Select **Current** in the bottom menu, select it again to switch between **ACA** (AC current) or **DCA** (DC current).
2. Connect the black test lead to the **COM** terminal on the top of the oscilloscope and the red test lead to the **V/Ω/C** terminal.
3. Probe the test points and read the display.

11.4.2 AC/DC current measurement

1. Push **DMM** button on the front panel. Select **Current** in the bottom menu, select it again to switch between **ACA** (AC current) or **DCA** (DC current).
2. Insert the current ext module provided with the oscilloscope into the **COM** terminal and **V/Ω/C** terminal on the top of the oscilloscope.
3. Connect the black test lead to the **COM** terminal on the top of the oscilloscope. Connect the red test lead to the **mA** terminal.
4. Turn off the power of the measured circuit. Discharge all high- voltage capacitors.
5. Disconnect the circuit path to be tested. Connect the black test lead to one side of the circuit (with a lower voltage); connect the red test lead to the other side (with a higher voltage). Reversing the leads will produce a negative reading, but will not damage the multimeter.
6. Turn on the power of the measured circuit, and read the display.
7. Turn off the power of the measured circuit and discharge all high-voltage capacitors. Remove the test leads and restore the circuit to the original condition.

11.4.3 Resistance measurement

1. Press the **DMM** button on the front of the device. Then press **R** in the lower menu several times to toggle between resistance, diode and capacitance until **R** is highlighted.
2. Connect the black test lead to the **COM** terminal on the top of the oscilloscope and the red test lead to the **V/Ω/C** terminal.
3. Connect the test probes to the (voltage-free) electrical conductor to be measured and read the measured value on the digital display of the multimeter window.

Note: Never carry out a resistance measurement on a live conductor to avoid damaging the device.

11.4.4 Testing diodes

1. Press the DMM button on the front of the device. Then press R in the lower menu several times to toggle between resistance, diode and capacitance until  is highlighted.
2. Connect the black test lead to the **COM** terminal on the top of the oscilloscope and the red test lead to the **V/Ω/C** terminal.
3. Connect the red test tip to the anode of the diode and the black test tip to the cathode of the diode. The cathode is marked with a ring around the body. Read the measured value in the digital display of the multimeter window.

11.4.5 Capacitance measurement

1. Press the DMM button on the front of the device. Then press R in the lower menu several times to toggle between resistance, diode and capacitance until C is highlighted.
2. Connect the black test lead to the **COM** terminal on the top of the oscilloscope and the red test lead to the **V/Ω/C** terminal.
3. Connect the test probes to the (discharged) capacitor to be measured and read the measured value in the digital display of the multimeter window.

Note: Measurements on a charged capacitor can damage the device. If you want to measure a capacitance below 5nF, use the relative function before measuring to improve the measurement result.

11.4.6 Continuity test

1. Press the DMM button on the front of the device. Then press On-off in the lower menu.
2. Connect the black test lead to the **COM** terminal on the top of the oscilloscope and the red test lead to the **V/Ω/C** terminal.
3. Connect the test probes to the (voltage-free) electrical conductor to be measured and read the measured value on the digital display of the multimeter window. If the resistance value is below 50Ω, the continuity signal sounds.

Note: Never carry out a resistance measurement on a live conductor to avoid damaging the device.

11.5 Multimeter features

11.5.1 Data hold Mode

With the data hold mode you are able to freeze the screen with the measured values at any time:

1. Select **Hold** in the bottom menu as **ON**. **HOLD** will be shown on the display.
2. Select **OFF** to exit this mode

11.5.2 Information display

1. Select **Configure** in the bottom menu, select **Show Info** in the right menu as **ON**. The information window will be shown on the display.
2. Select **OFF** to hide.

11.5.3 Auto or manual range

The automatic range is set as the default. Follow the steps below to switch between automatic or manual range selection:

1. Select **Configure** in the bottom menu.
2. Select **Auto Range** in the right menu, **AUTO** will be shown on the display.
3. Select **Switch Range** in the right menu, **MANUAL** will be shown on the display. Press this softkey to switch range.

Note: When testing diode, testing continuity, and measuring capacitance, manual range is disabled.

11.5.4 Relative measurements

Sets the current measured value to zero. The measurement is the difference between the reference value and the current measurement display.

1. Select **Configure** in the bottom menu, select **Relative** in the right menu to enter the relative mode.
The measurement value at this time is stored as the reference value, and displayed behind Δ
In this mode, current reading = input value - reference value.
2. Press it again to exit the mode

Note: This function is not available when measuring resistance, diodes, and testing for continuity.

11.6 Multimeter recorder





You can use the multimeter data recorder to record the measurements when measuring current / voltage with the multimeter function (P 1206, P 1207).

Press the Utility button, choose Function from the bottom menu, and choose DAQ from the left menu.

The controls of the DAQ menu are shown as follows:

Function menu	Settings	Description
Set	Interval	Set the recording interval (0.5s - 10s, step by 0.5s)
	Duration	"d h m s" stands for day, hour, minute, second. for example "1 02:50:30" means one day, 2 hours, 50 Minutes and 30 seconds. Press Duration to switch between the time units. Turn the M button to adjust the value. Maximum duration: 3 days for internal storage, 10 days for external storage.
	Enable	Switch the recorder function on or off
START STOP	Start or stop recording	
Storage	Internal External	Save to internal or external storage
Export	When internal storage is selected, you can export the internal recording file to a USB storage device	

To record the current / voltage measurements off he multimeter proceed as follows:

1. Press the DMM button on the front to access the multimeter function. Select Current or Voltage in the bottom menu.
If you want to switch to relative mode, select Configure in the bottom menu and then Relative in the right menu
2. Press the Menu button, select Tool and open the Function menu in the lower menu. Now select DAQ in the left menu
3. Select Storage in the bottom menu to select Internal or External in the right menu. If you choose external, insert the USB storage device into the USB port on the front
4. Select Settings and set Enable to On in the right menu
5. Select Interval in the menu on the right and use the  or  buttons to set the range
6. Select Duration in the right menu, press it to switch between the time units, use the buttons  or  to set the range
7. Select START in the lower menu
8. If external storage is selected: The instructions are displayed on the screen. The recording file is named "Multimeter_Recorder.csv". If a file with the same name already exists on the USB storage device, it will be overwritten. (If you want to keep the existing file, save it to a different location beforehand.) Select STRT from the bottom menu to start recording
9. When the recording time reaches the set duration, the recording will stop. If you want to end the recording early, select Stop in the lower menu

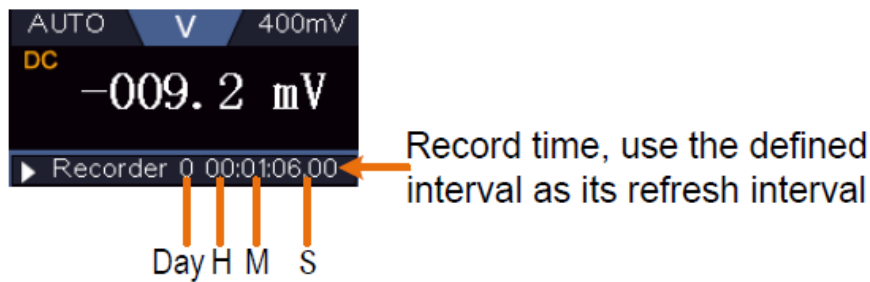

Figure 5.4 Recording the measurement

10. When the internal storage is selected: You can export the internal recording file to a USB storage device. Insert the USB storage device into the USB port on the front of the device. Select Export in the lower menu. The instructions will appear on the screen. The export file is named "Multimeter_Recorder.csv". If a file with the same name already exists on the USB storage device, it will be overwritten. (If you want to keep the existing file, back it up to a different location beforehand.) Select Export from the bottom menu to export.

Graphical representation of the measurement data with a spreadsheet:

You can open the CSV file with Microsoft Excel or your favorite spreadsheet application and create charts based on the data. Microsoft Excel 2010 is used as an example in the following steps.

1. Open Multimeter_Recorder.csv in excel

	A	B	C
1	DMM RECORDER		
2	Time interval:2.0(s)		
3	DCV		
4	RELATIVE:11.600000(mV)		
5	time	index	Voltage(mV)
6		1	-0.4

Figure 5.5 Recorded Data

2. Select the data you want to graph (see Figure 5.6).
3. On the Insert tab, in the Charts group, click Line, then click Draw Line in 2D Line (see Figure 5.6).
4. The graph is displayed (see Figure 5.6). If you want to keep the chart, save the file in XLS format.

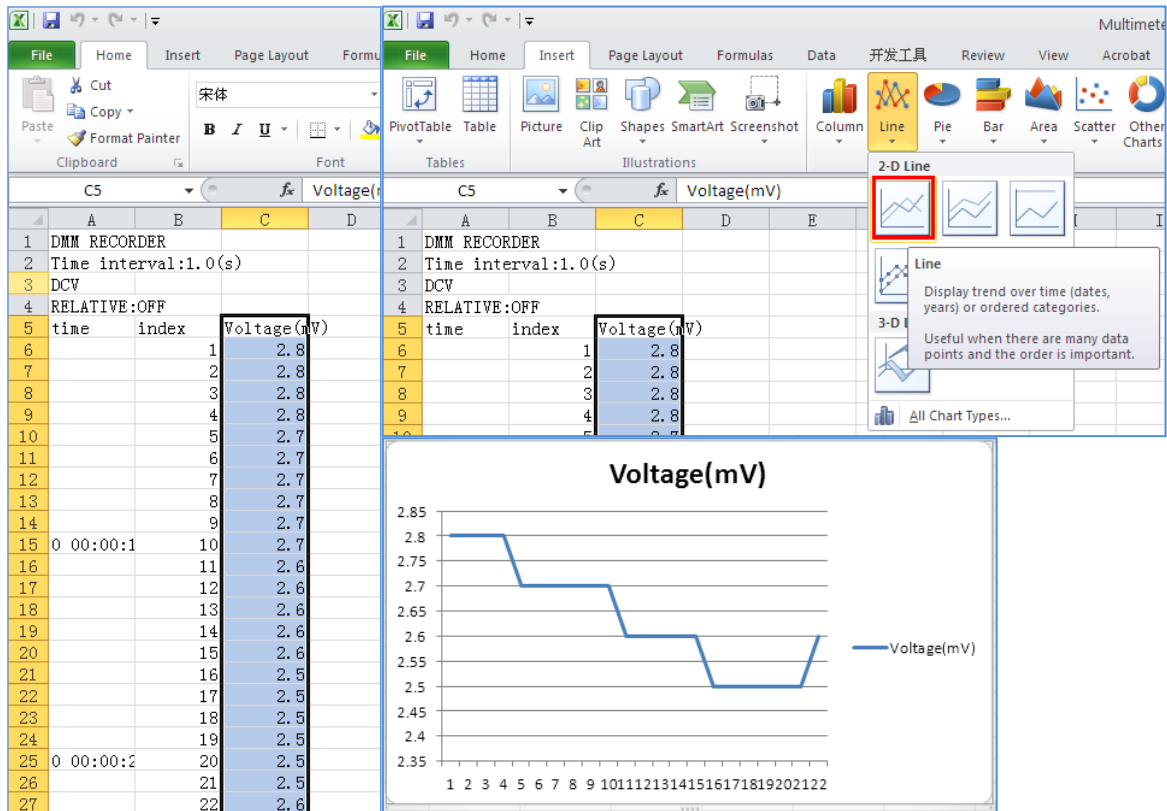

Figure 5.6 Recorded measurements

12. Communication with PC

This touchscreen oscilloscope series can be integrated into a network via LAN or connected directly to a PC via USB for data recording. To connect, proceed as described in the following sections.

12.1 USB port

1. **Connection:** Use a USB data cable to connect the **USB Device port** in the right panel of the oscilloscope to the USB port of a PC.
2. **Driver installation:** Install the PC software from the enclosed CD. The USB driver is installed automatically. In the software you can call up the help function with the F1 key.
3. **Port settings in the software:** Start the software and click on "Connections". Select "Ports Settings" and in the following menu under "Use Connection" on "USB". The detected oscilloscope is listed under "Available ports" and "automatically check USB" is displayed in green in the lower left corner of the main menu. With the arrow key next to the lettering you can reinstall the USB driver if necessary.

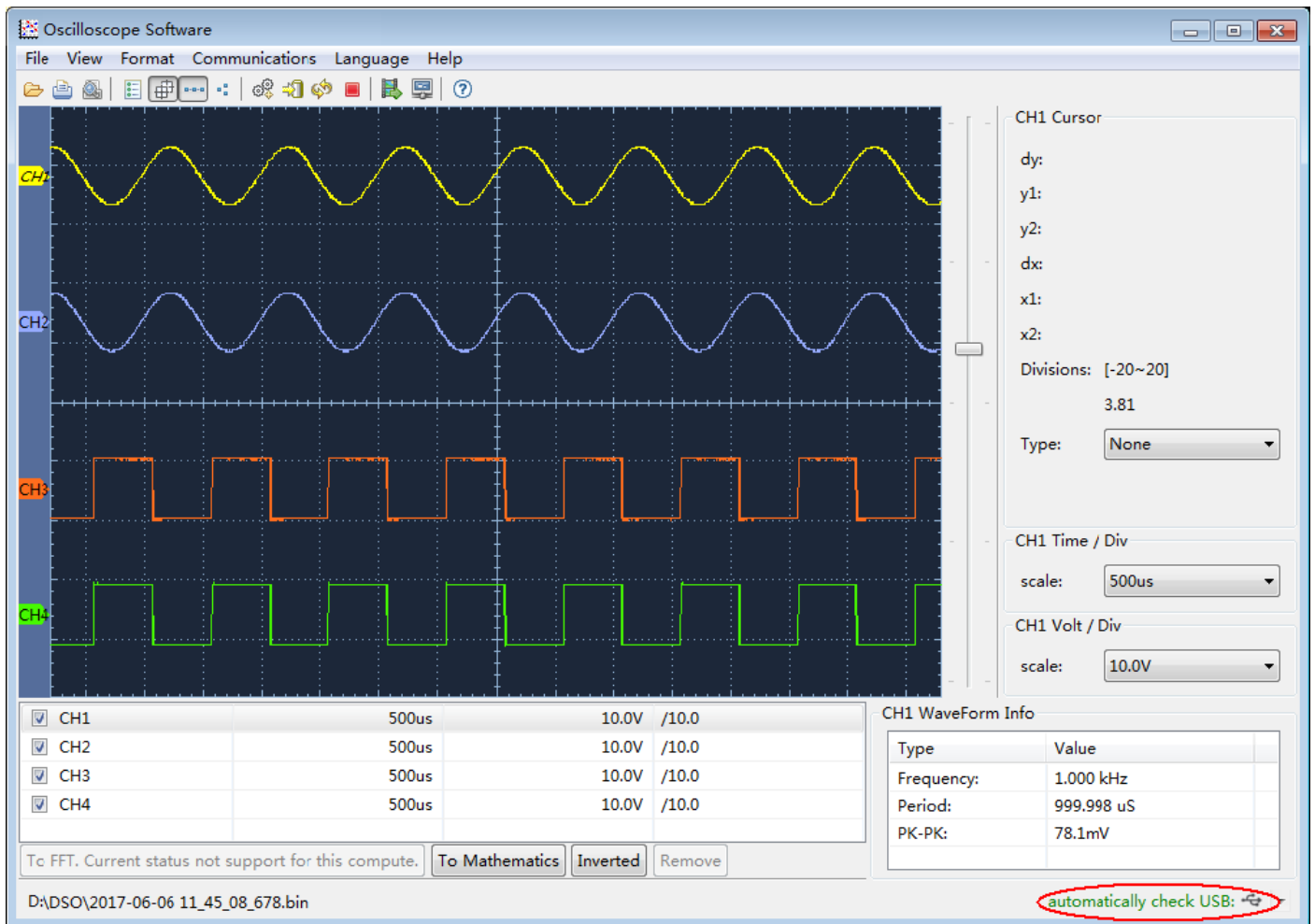

Figure 6.1 Display of the measured values using the software

12.2 LAN Port

Direct connection to the LAN input of the PC:

1. **Connection:** Plug the LAN cable into the LAN connection on the back of the oscilloscope. Plug the other end into the LAN port on the PC.
2. **Setting the computer's network parameters:** Since the oscilloscope does not support automatic IP address retrieval, you must assign a static IP address. In the following example we set the IP address to 192.168.1.71 and the subnet mask is 255.255.255.0.

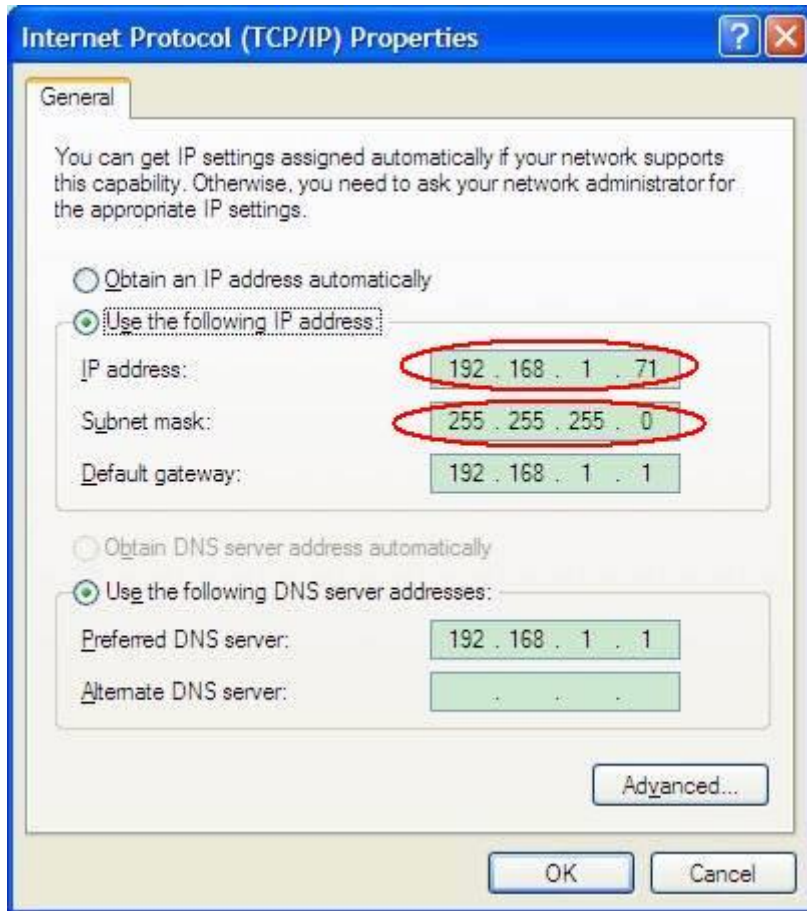

Figure 6.2 Network settings

- Setting the network parameters of the PeakTech® oscilloscope software:** Run the software on the computer. Under the Communications menu, choose Ports-settings. Set the “Connect using” option to LAN. The first three bytes of the IP address are the same as for the IP address in step (2). The last byte should be different. In this example we set the address to 192.168.1.72. The setting range for the port number is 0 ~ 4000. However, since a port below 2000 is always used, it is recommended to set a value above 2000. In this example we are using 3000.

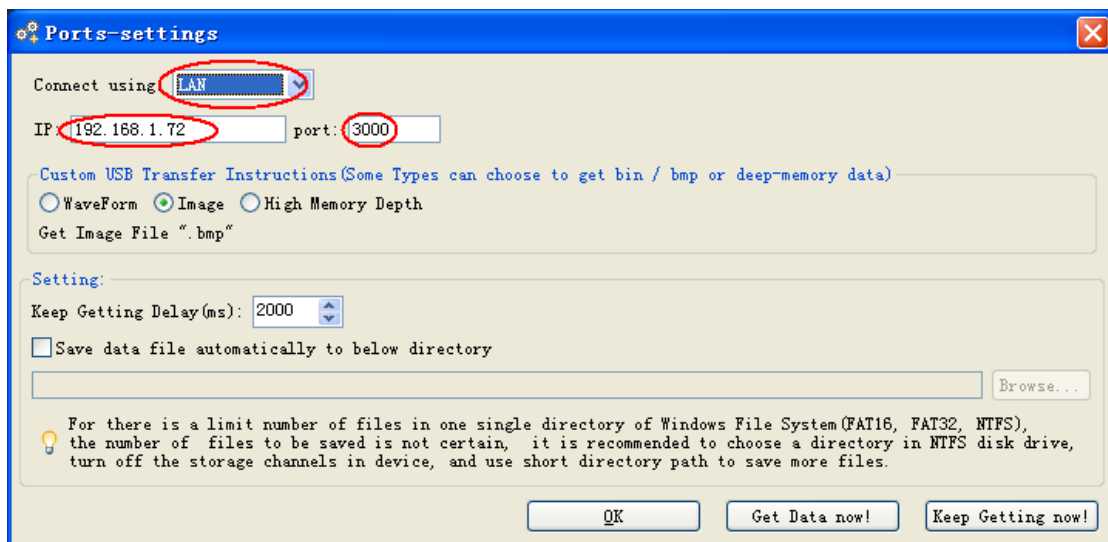

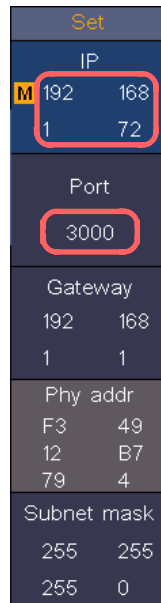

Figure 6.3 Network parameters

4. Set the network parameters of the oscilloscope:

Press the  icon and click **Utility**. After that select **Function** in the bottom menu and on the left sided menu appears LAN Set which you can select. In the bottom menu, set the **Type** item as **LAN**, and select **Set**. In the right menu, set **IP** and **Port** to the same value as the "Ports-settings" in the software in step (3). Select **Save set** in the bottom menu, it prompts "Reset to update the config". After resetting the oscilloscope, if you are able to load data in to the oscilloscope software, the connection is successful.



Set	
IP	
M 192	168
1	72
Port	
3000	
Gateway	
192	168
1	1
Phy addr	
F3	49
12	B7
79	4
Subnet mask	
255	255
255	0

Figure 6.4 Set the network parameters of the oscilloscope

13. Specification

Unless otherwise stated, the technical specifications only apply to probe damping to 10X. Only if the oscilloscope first meets the following two conditions can these specification standards be achieved.

- The device should run continuously for 30 minutes
- Perform “Self-calibration” if the operating temperature changes by up to or even more than 5 °C (see “Performing Self-Calibration”)
- All technical data, with the exception of those labeled “typical”, can be met

Description		Specifications			
Bandwidth		P 1206	70 MHz		
		P 1207	120 MHz		
		P 1211	70 MHz		
		P 1212	100 MHz		
Channels		P 1206	2 CH		
		P 1207	2 CH		
		P 1211	4 CH		
		P 1212	4 CH		
Vertical resolution (A/D)		P 1206	8 bit		
		P 1207	8 bit		
		P 1211	8 bit		
		P 1212	8 bit		
Acquire	Mode	Normal, Peak Detect, Average			
	Waveform sample rate	45.000 wfms/s			
	Sampling rate	P 1206	1CH / 2 CH	1 GSa/s, 500 MSa/s	
		P 1207	1CH / 2 CH	1 GSa/s, 500 MSa/s	
P 1211		1CH / 2 CH / 4 CH	1 GSa/s, 500 MSa/s, 250 MSa/s		
P 1212		1CH / 2 CH / 4 CH	1 GSa/s, 500 MSa/s, 250 MSa/s		
Input	Input coupling	DC, AC, Ground			
	Input impedance	1 MΩ±2%, in parallel with 15 pF±5 pF			
	Probe attenuation factor	0.001X - 1000X, 1 – 2 – 5 steps			
	Max. input voltage	400 V (DC + AC Peak)			
	Bandwidth limit	20 MHz, full bandwidth			

Description		Specifications		
	Channel to channel isolation	50Hz: 100 : 1 10MHz: 40 : 1		
	Time delay between channels (typical)	150 ps		
Horizontal system	Sampling rate range	P 1206 P 1207	Dual CH	0.05 Sa/s - 500 MSa/s
			Single CH	0.05 Sa/s – 1 GSa/s
		P 1211 P 1212	Four CH	0.05 Sa/s - 250 MSa/s
			Dual CH	0.05 Sa/s - 500 MSa/s
			Single CH	0.05 Sa/s – 1 GSa/s
	Interpolation	(Sinx)/x, x		
	Max. record length	When four channels are turned on, the max record length is 10M, max 20M for two channels and max 40M for one channel		
	Scanning speed (S/div)	2ns/div - 1000s/div, 1 – 2 – 5 steps		
	Sampling rate / relay time accuracy	±10 ppm max (Ta = +25°C)		
	Interval (ΔT) accuracy (DC - 100MHz)	Single: ±(1 Interval time +1 ppm×reading+0.6 ns); Average >16: ±(1 Interval time +1 ppm×reading+0.4 ns)		
Vertical system	Sensitivity	1 mV/div - 10 V/div		
	Displacement	±2 V (1 mV/div – 50 mV/div); ±20 V (100 mV/div – 1 V/div); ±200 V (2 V/div – 10 V/div)		
	Low frequency	≥10 Hz (at input, AC coupling, -3 dB)		

Description		Specifications		
	Rise time (at input typical)	P 1206	≤ 5.0 ns	
		P 1207	≤ 2.9 ns	
		P 1211	≤ 5.0 ns	
		P 1212	≤ 3.5 ns	
DC gain accuracy		1 mV; ±4% ≥2 mV; ±3%		
DC accuracy (average)		Delta Volts between any two averages of ≥16 waveforms acquired with the same scope setup and ambient conditions (ΔV): ±(3% rdg + 0.05 div)		
Waveform inverted ON/OFF				
Measurement	Cursor		ΔV, ΔT, ΔT&ΔV between the cursors, auto Cursor	
	Automatic		Period, Frequency, Mean, PK-PK, RMS, Max, Min, Top, Base, Amplitude, Overshoot, Preshoot, Rise Time, Fall Time, +Pulse Width, -Pulse Width, +Duty Cycle, -Duty Cycle, Delay A→B [Ⓢ] , Delay A→B [Ⓣ] , Cycle RMS, Cursor RMS, Screen Duty, FRR, FRF, FFR, FFF, LRR, LRF, LFR, LFF, Phase A→B [Ⓢ] , Phase A→B [Ⓣ] , +Pulse Count, -Pulse Count, Rise Edge Count, Fall Edge Count, Area and Cycle Area	
	Waveform math		+, -, *, / ,FFT, FFTrms, Intg, Diff, Sqrt, User defined function, Digital filter (low pass, high pass, band pass, band reject)	
	Decoding type (not available)		UART, I2C, SPI, CAN	
	Waveform storage		100 Waveforms	
	Lissajous figure	Band-width	Full bandwidth	
		Phase difference	±3 degrees	
Communication port	USB Host, USB Device; Trig Out(Pass/Fail); LAN port			
Printer	PictBridge			
Counter	Supported			

13.1 Trigger

Description	Specification	
Trigger level range	Internal	±5 div from the screen center
Trigger level accuracy (typical)	Internal	±0,3 div
Trigger displacement	According to record length and time base	
Trigger holdoff range	100 ns – 10 s	
50 % level setting (typical)	Input signal frequency ≥ 50 Hz	
Edge Trigger	Slope	Rising, Falling
Video Trigger	Modulation	Support standard NTSC, PAL and SECAM broadcast systems
	Line number range	1-525 (NTSC) and 1-625 (PAL/SECAM)
Pulse Trigger	Trigger condition	Positive pulse: >, <, = Negative pulse: >, <, =
	Puls width range	30 ns to 10 s
Slope Trigger	Trigger condition	Positive pulse : >, <, = Negative pulse : >, <, =
	Time setting	30ns to 10s
Runt Trigger	Polarity	Positive, Negative
	Pulse width condition	>, =, <
	Pulse width range	30ns to 10s
Windows Trigger	Polarity	Positive, Negative
	Trigger position	Enter, Exit, Time

Description	Specification	
	Idle time	30ns to 10s
Timeout Trigger	Polarity	Positive, Negative
	Idle time	30ns to 10s
Nth Edge Trigger	Edge type	Rising, Falling
	Idle time	30ns to 10s
	Flanknummer	1 to 128
Logic Trigger	Logic Mode	AND, OR, XNOR, XOR
	Input mode	H,L, X, Rising, Falling
	Output mode	Goes True, Goes False, Is True >, Is True <, Is True =
UART Trigger	Polarity	Timeout
	Trigger condition	30ns to 10 s
	Baud rate	4 bit to 32 bit
	Data bits	5 bit, 6 bit, 7 bit, 8 bit
I2C Trigger	Trigger condition	Start, Restart, Stop, ACK Lost, Address, Data, Addr/Data
	Address bits	7 bit, 8 bit, 10 bit
	Address range	0 to 127, 0 to 255, 0 to 1023
	Byte length	1 to 5
CAN Trigger (optional)	Signal type	CAN_H, CAN_L, TX, RX

Description	Specification	
	Trigger condition	Start of Frame, Type of Frame, Identifier, Data, ID & Data, End of Frame, Missing Ack, Bit Stuffing Error
	Baud rate	Common, Custom
	Sample Point	5% to 95%
	Frame type	Data, Remote, Error, Overload

13.2 Multimeter

Description	Specification
Maximum display of measuring range	4½ digits (Max 19999 – count)
Diode measurement	0 V – 2 V
Input impedance	10 MΩ
Continuity test	<50Ω sounds a beeper
Capacitance	2nF - 20mF: ±(4.0%+10 digit)
Voltage measurement	DCV: 20mV, 200mV: ±(0.5%+10digit); 2V, 20V, 200V: ±(0.3%+5digit); 1000V: ±(0.5%+5digit) Max. Input: DC 1000V ACV: 20mV, 200mV, 2V, 20V, 200V: ±(0.8%+10digit) 750V: ±(1%+10digit) Frequency: 40Hz-1000Hz, Max. Input: AC 750V (virtual size)
Current measurement	DCA: 10A: ±(2%+10digit) ACA: 10A: ±(2.5%+10digit)
Resistance measurement	200Ω: ±(0.8%+10digit) 2KΩ - 2MΩ: ±(0.5%+3digit) 20MΩ: ±(0.8%+5digit) 100MΩ: ±(5.0%+10digit)

14. General specifications

Display

Display type	8" colored LCD (Liquid Crystal Display)
Display resolution	800 (Horizontal) × 600 (Vertical) Pixels
Display colors	65536 colors, TFT screen

Probe compensation

Output voltage (typical)	About 5 V, Peak-to-Peak voltage ≥ 1 M Ω .
Frequency (Typical)	Square wave of 1 KHz

Power supply

Mains input voltage	100V – 240 VACRMS, 50/60 Hz, CAT II
Power consumption	<15 W
Fuse	2 A, T class, 250 V
Battery	7.4V, 8000mAh The battery can last approximately 5 hours, after a full charge

Environmental conditions

Temperature	Operating temperature: 0 °C - 40 °C Storage temperature: -20 °C - 60 °C
Relative humidity	$\leq 90\%$
Height	Operating: 3,000 m Non - operating: 15,000 m
Cooling method	Fan cooling

Sizes / Weight

Dimension	270 mm × 191 mm × 48 mm (L*H*W)
Weight	Approx. 1.7 kg

Notes on using the lithium-ion battery:

Caution: It is essential to observe the following precautionary measures when handling Li-Ion batteries:

- When using Li-Ion batteries, do not work in environments with extreme temperatures or very high pressure differences, as this can lead to unwanted chemical reactions inside the battery. This can lead to smoke, fire or the battery bursting
- Never bring the battery into contact with fire or heat it. Avoid storing the battery in direct sunlight
- Never destroy or open the housing of the battery by drilling, cutting, hitting or other physical means to avoid an internal short circuit with possible heat / fire development
- Never immerse the battery in water or connect the positive (+) and negative (-) poles with a metallic object
- Store the battery at a minimum of 0 ° C and a maximum of 40 ° C
- In order to maintain the battery performance even after long periods of storage, charge the battery at least once every six months
- Replace the battery only with an identical original part
- A Li-Ion battery does not belong in the household waste and should be handed in separately to the local waste disposal station or sent back directly to the dealer / manufacturer

Statutory information on battery regulations

Many devices come with batteries that are used, for example, to operate remote controls.

Batteries or rechargeable batteries can also be permanently installed in the devices themselves.

As an importer, we are obliged to sell these batteries in accordance with the Battery Ordinance, to

Point out the following to our customers:

Please dispose of old batteries as prescribed by law - disposal in household waste is expressly prohibited according to the Battery Ordinance - at a municipal collection point or give them to the local shop free of charge. Batteries received from us can be returned free of charge after use at the address given on the last page or sent back to us by post with sufficient postage.

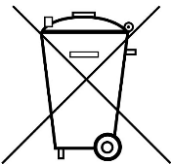

Batteries that contain harmful substances are marked with a crossed out symbol

Garbage can, similar to the symbol in the figure on the left. Under the

The garbage can symbol shows the chemical name of the pollutant, for example "Cd" for cadmium, "Pb" for lead and "Hg" for mercury.

You can find more informations on the Battery Ordinance at the Federal Ministry for the Environment, Nature Conservation and Reactor safety.

All rights, including those of translation, reprinting and reproduction of this manual or parts of these manual, are reserved.

Reproductions of any kind (photocopy, microfilm or any other process) are only allowed with a written permission of the editor.

Last status at time of printing. Technical changes to the device that serve progress, are reserved.

Misprints and errors are reserved.

We hereby confirm that all devices meet the specifications stated in our documents. All devices are calibrated in the factory after production. It is recommended to recalibrate the unit after 1 year.

© **PeakTech**® 06/2021/ Lie/PL